



I AM HYGIENIC*

* Je suis hygiènique



Ris|<Control®

GUIDE TECHNIQUE
TECHNICAL GUIDE

SOMMAIRE

TABLE OF CONTENT



Visionnez la vidéo Riskontrol



Watch the Riskontrol video

1	Règles générales d'utilisation des adaptateurs General rules for using the adapters	5
2	Adaptateurs : règles et schémas de montage Adapters : assembly rules and drawings	9
3	Récapitulatif des marques de fauteuils, seringues et adaptateurs correspondants Summary of chairs and syringes brands and corresponding adapters	55
4	Incidents courants et solutions Troubleshooting	73
5	Index des adaptateurs Adapters index	77



1

RÈGLES GÉNÉRALES D'UTILISATION DES ADAPTATEURS

GENERAL RULES FOR USING THE ADAPTERS

A lire impérativement avant d'utiliser les adaptateurs RISKONTROL

1. Nettoyer/stériliser l'adaptateur avant sa 1ère utilisation.
2. L'adaptateur doit impérativement être monté sur la seringue selon le dessin de montage avant d'utiliser l'embout jetable RISKONTROL.
LE LABORATOIRE PRODUITS DENTAIRE PIERRE ROLLAND DÉCLINE TOUTE RESPONSABILITÉ EN CAS DE DÉTERIORATION :
 - DE LA SERINGUE LORS DU MONTAGE DE L'ADAPTATEUR.
 - DE LA SERINGUE ET/OU DE L'ADAPTATEUR LORS D'UTILISATION D'EMBOUS AUTRES QUE LES EMBOUTS RISKONTROL.
3. Pour une bonne utilisation des adaptateurs RISKONTROL, la **pression** de l'air et de l'eau doit être de **3,5 bars minimum** (environ 50 PSI).
4. **IMPORTANT** : Une fois l'adaptateur en place, vérifiez que l'eau sort du tube le plus au centre de la partie ronde de l'adaptateur (voir dessin ci-dessous).
5. Les adaptateurs et les seringues avec des joints en caoutchouc doivent être lubrifiés avec de l'huile de silicone avant le montage.
6. Nettoyer l'extérieur de l'adaptateur avec une lingette désinfectante après chaque utilisation.
Il faut enlever **tous les mois** l'adaptateur de la seringue et lubrifier les joints.
7. L'adaptateur peut être nettoyé au bac à ultra-sons tous les six mois environ après l'avoir démonté de la seringue et avoir enlevé les joints.
8. L'adaptateur est stérilisable à l'autoclave (après l'avoir démonté de la seringue et avoir enlevé les joints) (132 °C - 2,9 bars - 4 minutes ou 134 °C - 2,2 bars - 18 minutes).
9. L'adaptateur s'utilise uniquement avec les embouts jetables RISKONTROL (stériles ou non)
10. Les tubes des adaptateurs peuvent être débouchés à l'aide d'un racleur Ø 40.

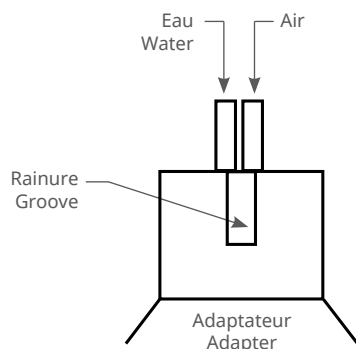

To read imperatively before using the RISKONTROL adapters

1. Clean/sterilize the adapter before its first use.
2. The adapter must imperatively be set on the syringe according to the assembly drawing before using the RISKONTROL disposable tips.
THE LABORATORY PRODUITS DENTAIRE PIERRE ROLLAND DECLINES ANY RESPONSABILITY IN CASE OF DAMAGES:
 - OF THE SYRINGE DURING THE ASSEMBLING OF THE ADAPTER.
 - OF THE SYRINGE AND/OR THE ADAPTER IF TIPS OTHER THAN RISKONTROL TIPS ARE USED.
3. For a good use of the RISKONTROL adapters, the air and water **pressure** must be **3.5 bars minimum** (about 50 PSI).
4. **IMPORTANT**: Once the adapter in position, verify that the water comes out of the tube the most in the centre of the round part of the adapter (see drawing on the opposite page).
5. The adapters and syringes with rubber O-rings must be lubricated with silicon oil before the assembling.
6. After each use, clean the external part of the adapter with a disinfecting wipe.
Every month, you must remove the adapter from the syringe and lubricate the O-rings.
7. The adapter can be cleaned in an ultrasonic bath nearly every six months after removing it from the syringe and removing the O-rings.
8. The adapter can be sterilized in an autoclave (after removing it from the syringe and removing the O-rings) (132°C - 2.9 bars - 4 minutes or 134°C - 2.2 bars - 18 minutes).
9. The adapter can only be used with the RISKONTROL disposable tips (sterile or not).
10. The tubes of the adapters can be cleaned out with a scraper Ø 40.

2

ADAPTATEURS
RÈGLES ET SCHÉMAS DE MONTAGE

ADAPTERS
ASSEMBLY RULES AND DRAWINGS



ADEC INOX

Adaptateur avec 1 joint
Adapter with 1 O-ring

Si votre seringue n'est pas marquée ADEC et qu'il y a une fuite, enlever le grand joint de l'adaptateur.
If ADEC is not written on your syringe and if there is a leak, remove the big O-ring of the adapter.



Tirer sur l'embout d'origine de la seringue.
Pull on the original tip of the syringe.

Dévisser l'écrou avec une clé alène.
Unscrew the nut with an awl key.

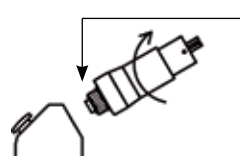

Vérifier que le petit joint est au bout de l'adaptateur.
Check that the small O-ring is at the end of the adapter.

Lubrifier le joint et visser l'adaptateur.
Lubricate the O-ring and screw the adapter.

Mettre en place l'embout jetable.
Insert the disposable tip.

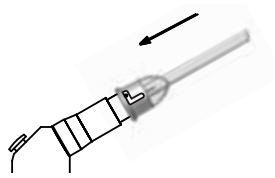

1

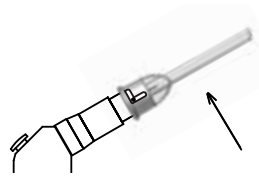

2

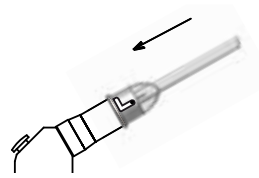

3



Ref. 200 195 : NV ADEC INOX

ANTHOS

Adaptateur avec 3 joints
Adapter with 3 O-rings

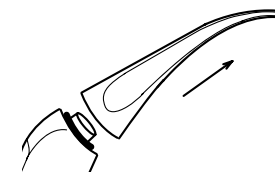
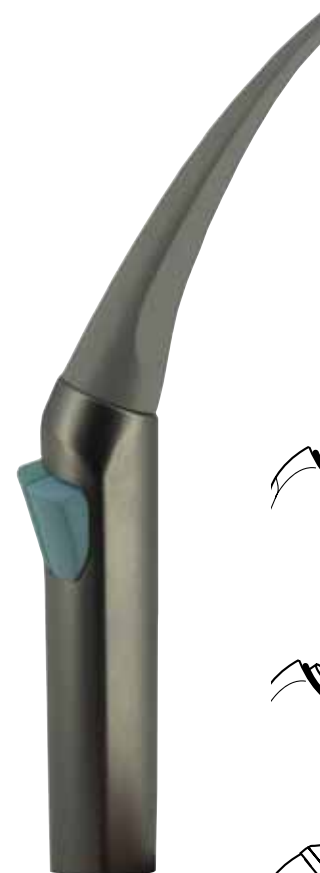

Enlever délicatement l'embout d'origine de la seringue en le tirant.
Remove softly the original tip from the syringe by pulling it.

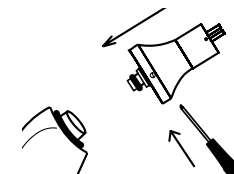

Lubrifier les joints de l'adaptateur, dévisser la petite vis, clipser l'adaptateur sur la seringue en le tournant.
Lubricate the O-rings of the adapter, unscrew the small screw, clip the adapter onto the syringe while turning it.

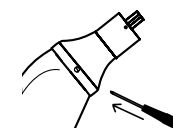

Visser la vis de l'adaptateur.
Screw the screw located on the adapter.

Mettre en place l'embout jetable.
Insert the disposable tip.



1



2

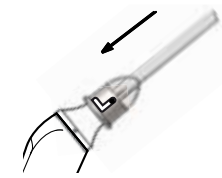

3



Ref. 200 197 : NV CEFLA INOX

ANTHOS

Adaptateur avec 2 joints
Adapter with 2 O-rings

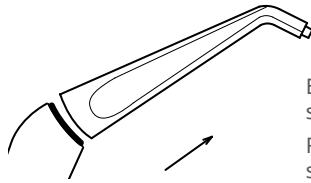

Enlever délicatement l'embout d'origine de la seringue en le tirant.
Remove softly the original tip from the syringe by pulling it.

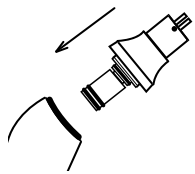

Lubrifier les joints de l'adaptateur, clipser l'adaptateur sur la seringue en le tournant.
Lubricate the O-rings of the adapter, clip the adapter onto the syringe while turning it.

Mettre en place l'embout jetable.
Insert the disposable tip.



1



2



3



Ref. 200 198 : NV CAS INOX

BELMONT NEW

Adaptateur avec 2 joints
Adapter with 2 O-rings

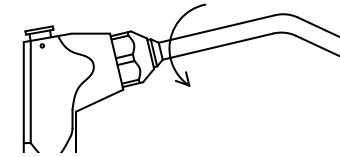

Dévisser l'embout d'origine de la seringue.
Unscrew the original tip of the syringe.

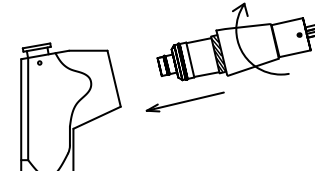

Lubrifier les joints et enfoncer l'adaptateur en le tournant, **puis visser l'écrou de l'adaptateur dans la seringue.**
Lubricate the 2 O-rings and push the adapter into the syringe while turning it, **then screw the nut from the adapter to the syringe.**

Mettre en place l'embout jetable.
Insert the disposable tip.

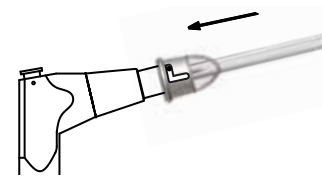

1

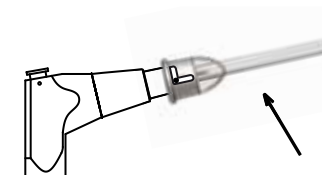

2

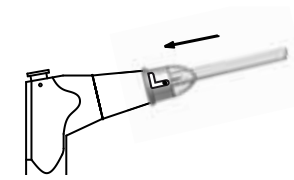

3



Ref. 200 158 : NV BELMONT New

CASTELLINI

Adaptateur avec 2 joints
Adapter with 2 O-rings

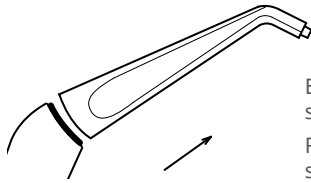

Enlever délicatement l'embout d'origine de la seringue en le tirant.
Remove softly the original tip from the syringe by pulling it.

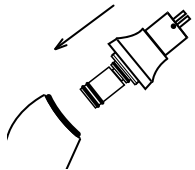

Lubrifier les joints de l'adaptateur, clipser l'adaptateur sur la seringue en le tournant.
Lubricate the O-rings of the adapter, clip the adapter onto the syringe while turning it.

Mettre en place l'embout jetable.
Insert the disposable tip.



1



2



3



Ref. 200 198 : NV CAS INOX

CASTELLINI LOGO NEW

Adaptateur sans joint
Adapter without O-ring

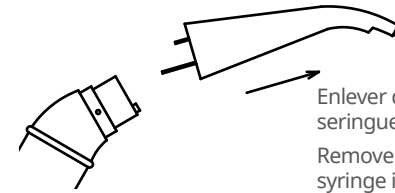
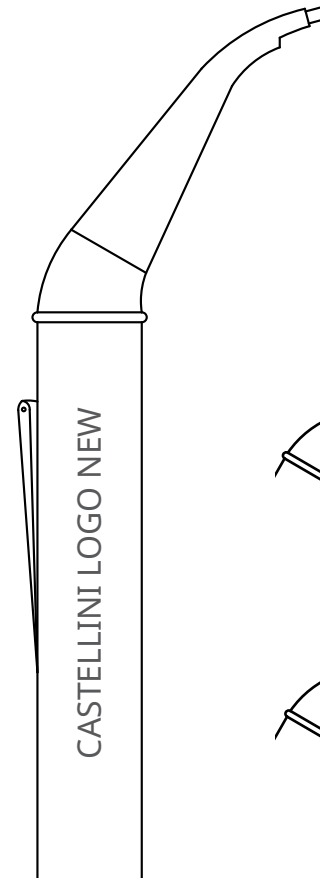

Enlever délicatement l'embout d'origine de la seringue en le tirant.
Remove softly the original tip from the syringe in pulling it.

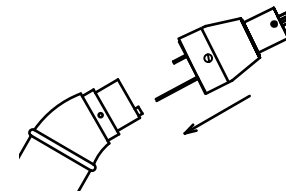

Mettre en place l'adaptateur en plaçant les 2 tubes dans les 2 trous, comme pour l'embout d'origine.
Set up the adapter onto the syringe, putting the 2 tubes into the 2 holes, as for the original tip.

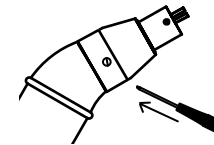

Visser la vis de l'adaptateur.
Screw the screw located on the adapter.

Mettre en place l'embout jetable.
Insert the disposable tip.

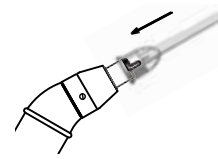

1



2

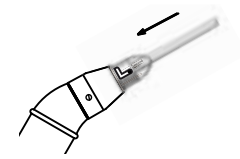

3



Ref. 200 184 : NV CASTELLINI LOGO New

CASTELLINI LOGO New

Adaptateur sans joint
Adapter without O-ring

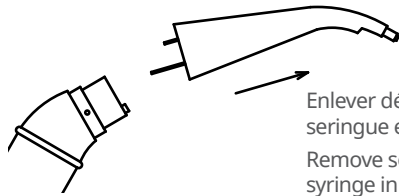
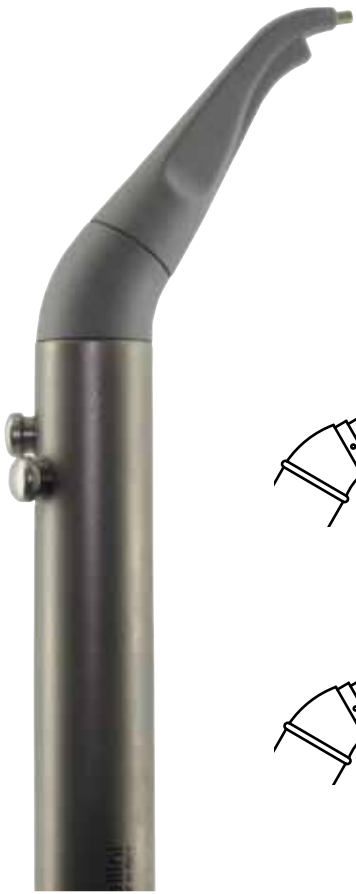

Enlever délicatement l'embout d'origine de la seringue en le tirant.
Remove softly the original tip from the syringe in pulling it.

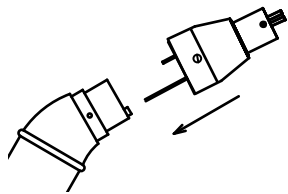

Mettre en place l'adaptateur en plaçant les 2 tubes dans les 2 trous, comme pour l'embout d'origine.
Set up the adapter onto the syringe, putting the 2 tubes into the 2 holes, as for the original tip.

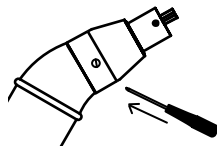

Visser la vis de l'adaptateur.
Screw the screw located on the adapter.

Mettre en place l'embout jetable.
Insert the disposable tip.

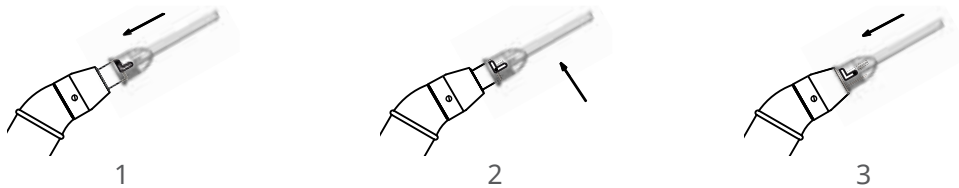

Ref. 200 184 : NV CASTELLINI LOGO New

CASTELLINI V

Adaptateur sans joint
Adapter without O-ring

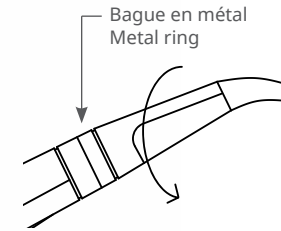

Dévisser l'embout d'origine de la seringue situé juste après la bague en métal.
Unscrew the original tip of the syringe located just right after the metal ring.

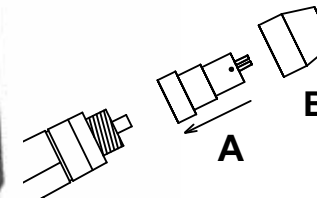

Lubrifier la seringue puis enfoncer la partie A de l'adaptateur en tournant, puis visser la partie B sur la seringue.
Lubricate the syringe and push in part A of the adapter while turning, then screw the part B on the syringe.

Mettre en place l'embout jetable.
Insert the disposable tip.

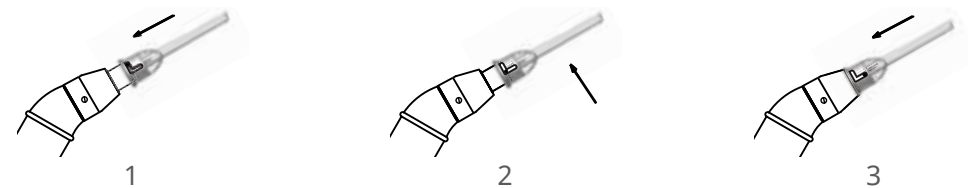

Ref. 200 163 : NV CASTELLINI V

DCI

Adaptateur sans joint
Adapter without O-ring

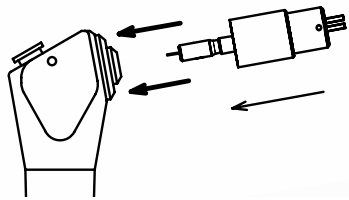
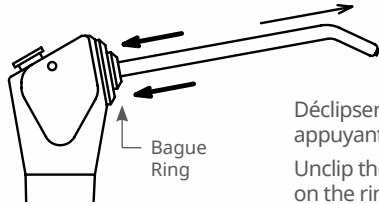

Déclipser l'embout d'origine de la seringue en appuyant sur la bague autour de cet embout.
Unclip the original tip of the syringe pressing on the ring around this tip.

Clipser l'adaptateur en appuyant sur la bague.
Clip the adapter pressing on the ring.

Mettre en place l'embout jetable.
Insert the disposable tip.

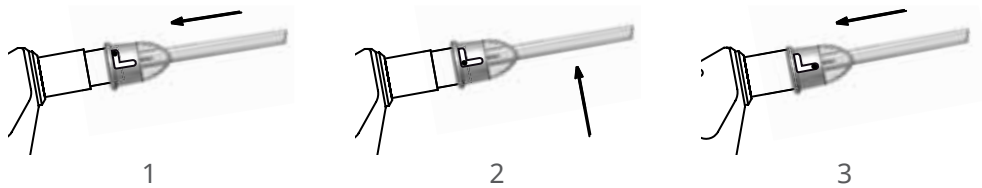

 Ref. 200 152 : NV DCI

DENTALEZ

Adaptateur avec 2 joints
Adapter with 2 O-rings

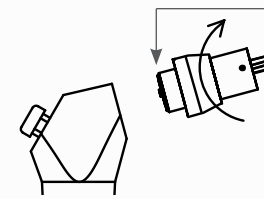
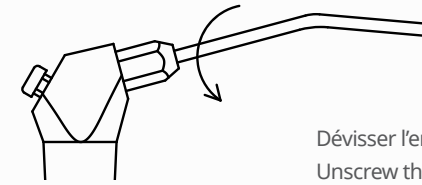

Dévisser l'embout d'origine de la seringue.
Unscrew the original tip of the syringe.

Vérifier que le petit joint est au bout de l'adaptateur.
Check that the small O-ring is at the end of the adapter.
Lubrifier les 2 joints puis visser l'adaptateur.
Lubricate the 2 O-rings then screw the adapter.

Mettre en place l'embout jetable.
Insert the disposable tip.

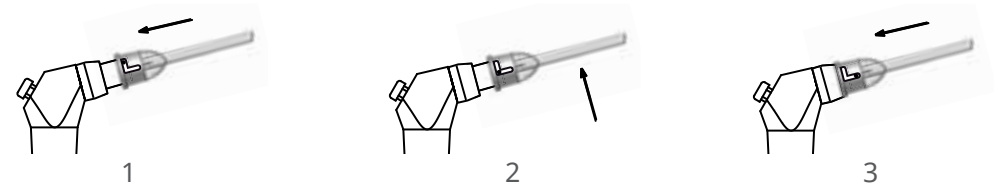

 Ref. 200 164 : NV DENTALEZ

ENGLE

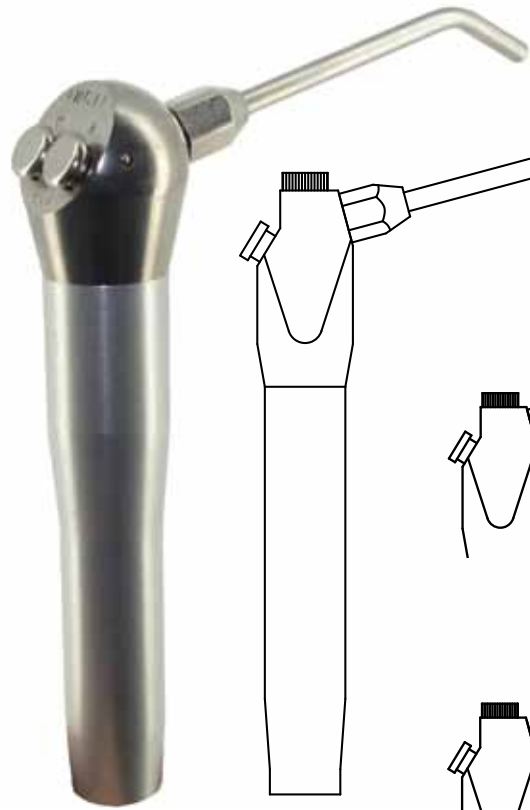

Adaptateur avec 2 joints
Adapter with 2 O-rings

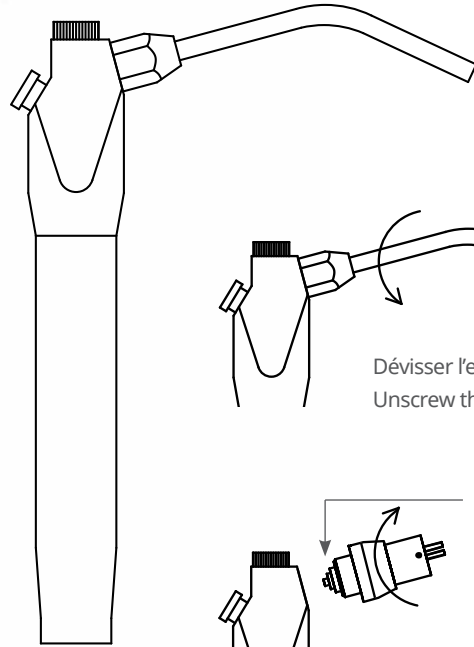

Dévisser l'embout d'origine de la seringue.
Unscrew the original tip of the syringe.

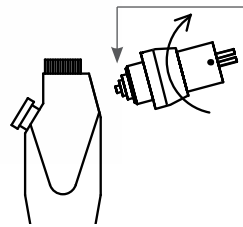

Vérifier que le petit joint est au bout de l'adaptateur.
Check that the small O-ring is at the end of the adapter.

Lubrifier les 2 joints puis visser l'adaptateur.
Lubricate the 2 O-rings then screw the adapter.

Nouvelle seringue
New syringe

Ancienne seringue
Old syringe

Mettre en place l'embout jetable.
Insert the disposable tip.

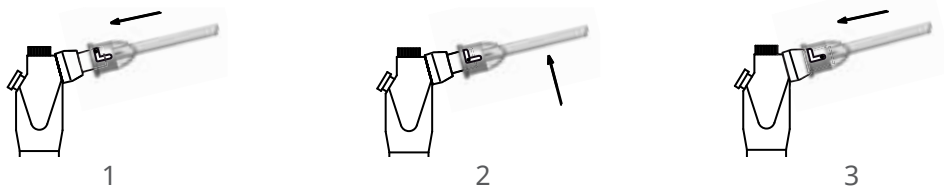

 Ref. 200 194 : NV ENGLE

FA C

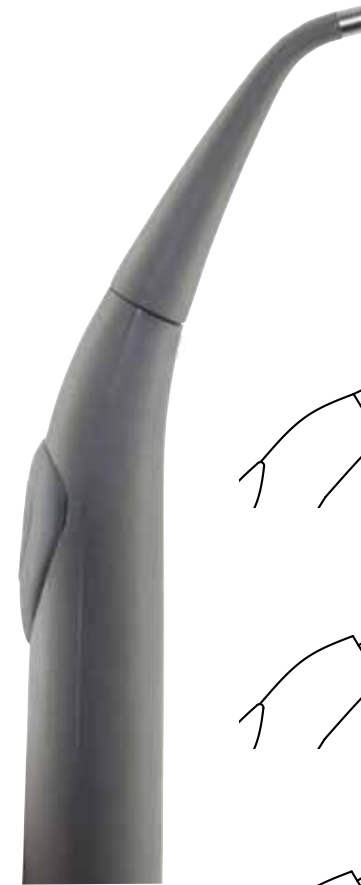

Adaptateur sans joint
Adapter without any O-ring

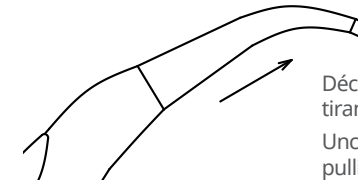

Déclipser l'embout d'origine de la seringue en tirant sur celui-ci.
Unclip the original tip of the syringe while pulling it out.

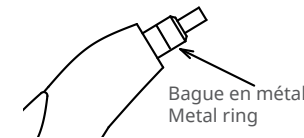

Bague en métal
Metal ring

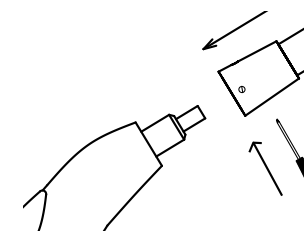

Enlever la bague en métal (le clip) de la seringue. Lubrifier la seringue puis dévisser la petite vis et clipser l'adaptateur sur la seringue en le tournant et revisser la petite vis.

Remove the metal ring (the clip) from the syringe. Lubricate the syringe then unscrew the small screw and clip the adapter on the syringe while turning it and screw again the small screw.

Mettre en place l'embout jetable.
Insert the disposable tip.

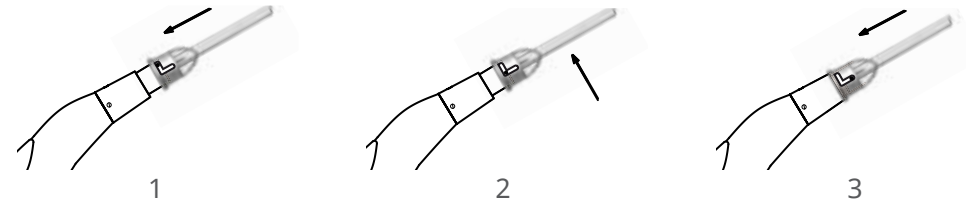

 Ref. 200 167 : NV FA C

FA C2

Adaptateur avec 1 joint à monter
Adapter with 1 O-ring to set up

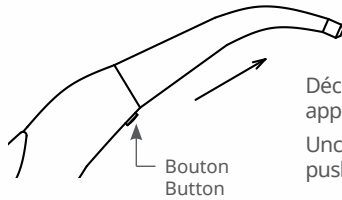

Déclipser l'embout d'origine de la seringue en appuyant sur le bouton.
Unclip the original tip of the syringe while pushing the button.

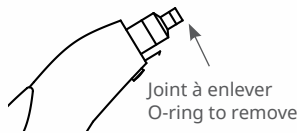

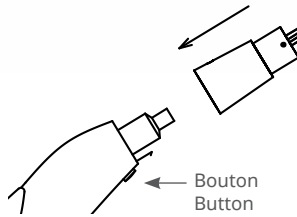

Enlever le petit joint situé au bout de la seringue et le remplacer par le joint fourni avec l'adaptateur.
Remove the small O-ring located at the end of the syringe and replace it by the one provided with the adapter.

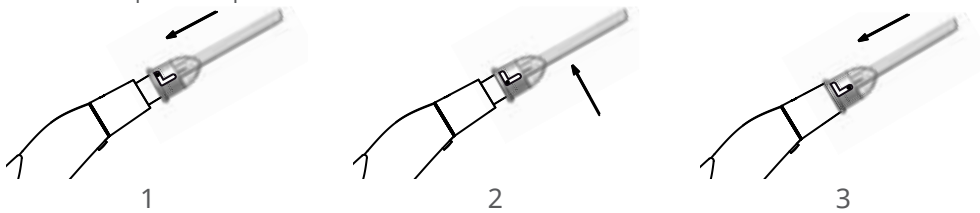

Lubrifier la seringue, appuyer sur le bouton de la seringue et enfoncer l'adaptateur sur la seringue en le tournant.
Lubricate the syringe, press the button of the syringe and push in the adapter on the syringe while turning it.

Mettre en place l'embout jetable.
Insert the disposable tip.



 Ref. 200 168 : NV FA C2

FA E

Adaptateur avec 2 joints
Adapter with 2 O-rings

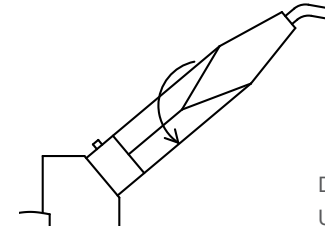
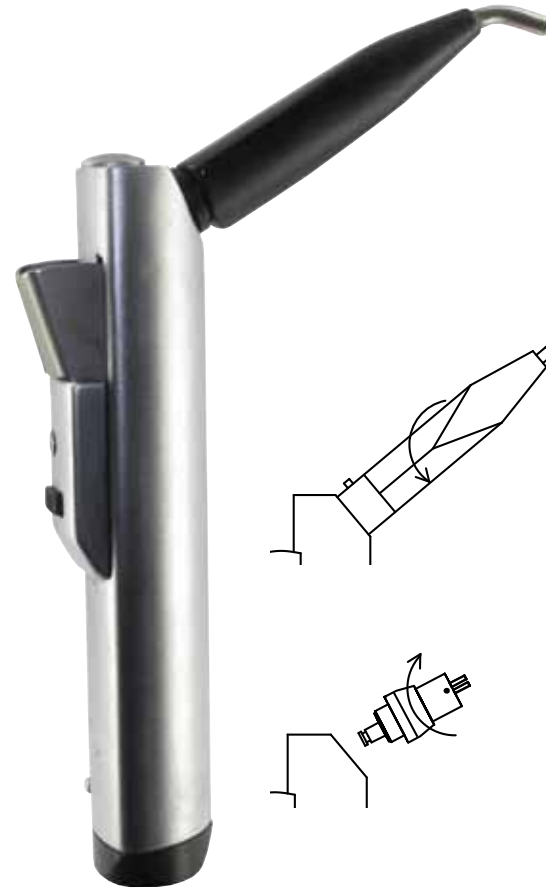

Dévisser l'embout d'origine de la seringue.
Unscrew the original tip of the syringe.

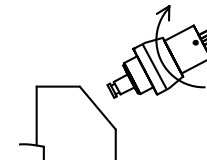

Lubrifier le joint et visser l'adaptateur.
Lubricate the O-ring and screw the adapter.

Mettre en place l'embout jetable.
Insert the disposable tip.

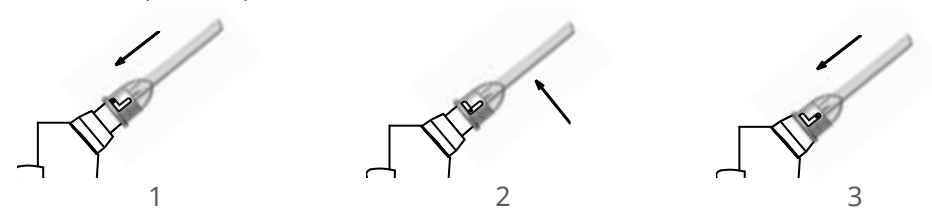

 Ref. 200 165 : NV FA E

FA E2

Adaptateur avec 2 joints
Adapter with 2 O-rings

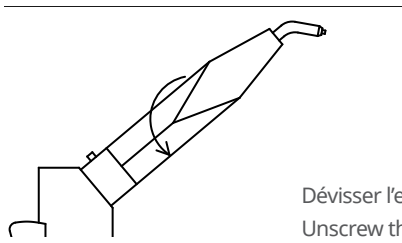
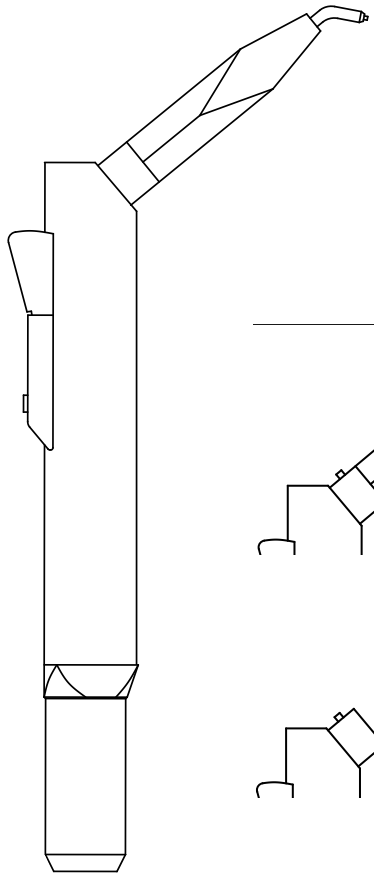

Dévisser l'embout d'origine de la seringue.
Unscrew the original tip of the syringe.

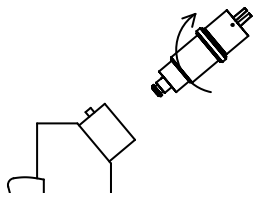

Lubrifier le joint et visser l'adaptateur.
Lubricate the O-ring and screw the adapter.

Mettre en place l'embout jetable.
Insert the disposable tip.

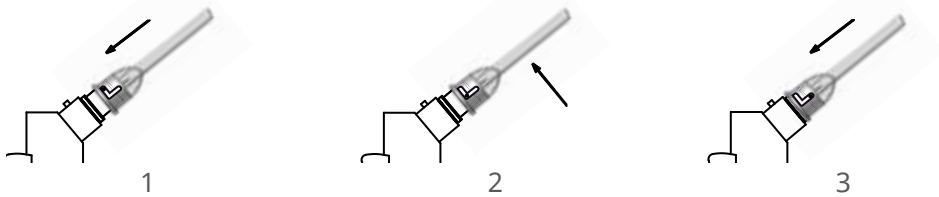

 Ref. 200 166 : NV FA E2

FA S1

Adaptateur sans joint
Adapter without any O-ring

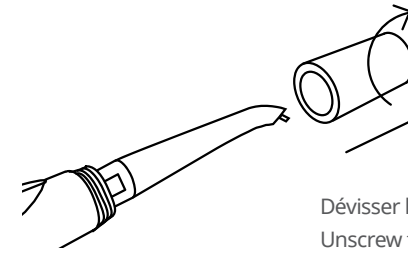

Dévisser l'écrou d'origine de la seringue.
Unscrew the original nut from the syringe.

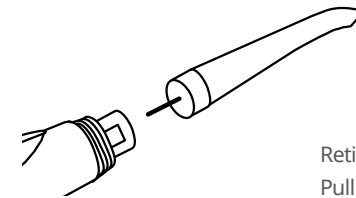

Retirer la partie restante en tirant dessus.
Pull the remaining part to remove it.

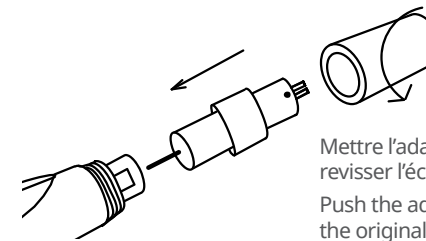

Mettre l'adaptateur dans la seringue puis revisser l'écrou d'origine.
Push the adapter into the syringe, then screw the original nut of the syringe.

Mettre en place l'embout jetable.
Insert the disposable tip.

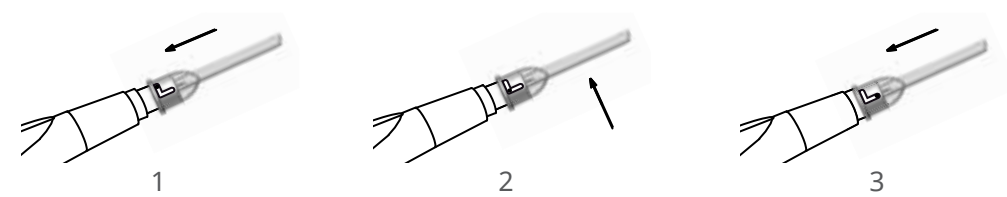

 Ref. 200 182 : NV FA S1

FLEX

Adaptateur sans joint
Adapter without O-ring

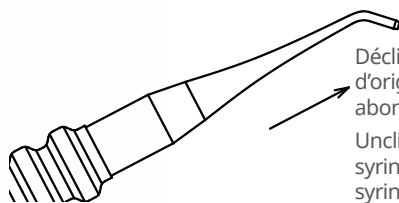

Déclipser délicatement l'embout d'origine de la seringue. Lubrifier abondamment la seringue.
Unclip softly the original tip of the syringe. Lubricate abundantly the syringe.

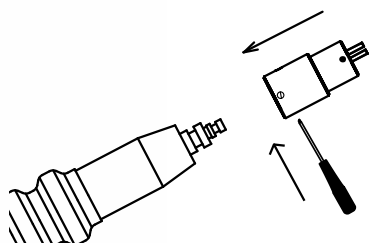

Dévisser la petite vis puis clipser l'adaptateur sur la seringue en le tournant et revisser la petite vis.
Unscrew the small screw then clip the adapter on the syringe while turning it and screw again the small screw.

Mettre en place l'embout jetable.
Insert the disposable tip.

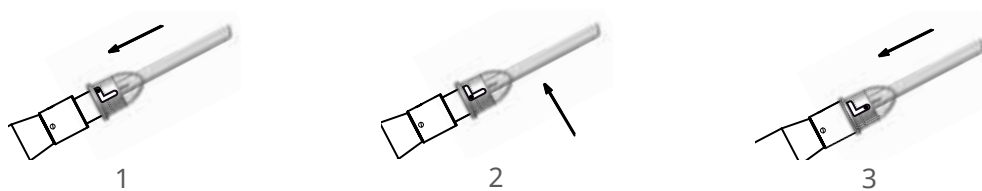

Ref. 200 169 : NV FLEX

KAVO C

Adaptateur sans joint
Adapter without any O-ring

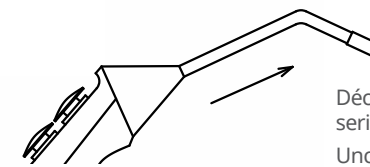
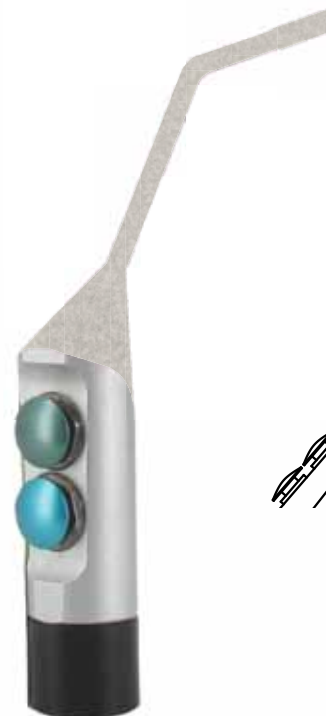

Déclipser l'embout d'origine de la seringue.
Unclip the original tip of the syringe.

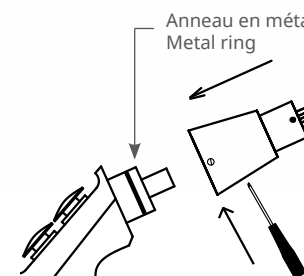

Vérifier que l'anneau en métal (le clip) est en bon état.
Check that the metal ring (the clip) is undamaged.

Lubrifier la seringue, dévisser la petite vis, clipser l'adaptateur sur la seringue en le tournant et revisser la petite vis.
Lubricate the syringe, unscrew the small screw, clip the adapter on the syringe while turning it, and screw again the small screw.

Pour seringues/
For syringes
KAVO MONDIAL
ATLANTICA
n° 5730600
n° 5730610

Mettre en place l'embout jetable.
Insert the disposable tip.

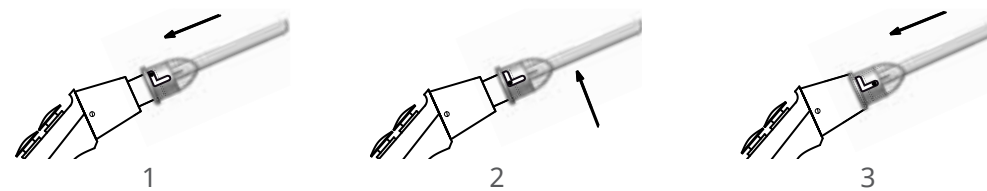

Ref. 200 171 : NV KAVO C

KAVO DB

Adaptateur avec 1 joint à monter
Adapter with 1 O-ring to set up

Déclipser l'embout d'origine de la seringue.
Unclip the original tip of the syringe.
Vérifier que les joints de la seringue sont en bon état.
Check that the O-rings of the syringe are undamaged.

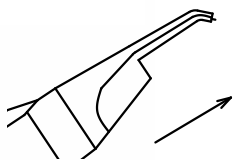

Enlever le petit joint situé au bout de la seringue (voir dessin ci-contre) et le remplacer par le joint fourni avec l'adaptateur.
Remove the small O-ring located at the end of the syringe (see drawing opposite) and replace it by the one provided with the adapter.

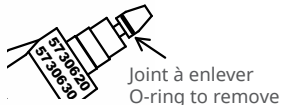

Lubrifier la seringue, clipser l'adaptateur sur la seringue en le tournant et visser la petite vis de l'adaptateur.
Lubricate the syringe, clip the adapter on the syringe while turning it, then screw the little screw of the adapter.

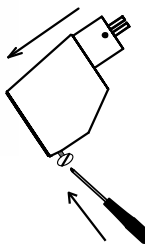

Lubrifier la seringue, clipser l'adaptateur sur la seringue en le tournant et visser la petite vis de l'adaptateur.

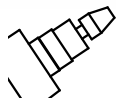

Pour seringues/For syringes
KAVO SYSTEMATICA n°5730620,
n°5730630, n°5730640 et n°5730650

Mettre en place l'embout jetable.
Insert the disposable tip.

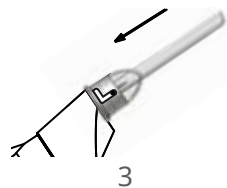
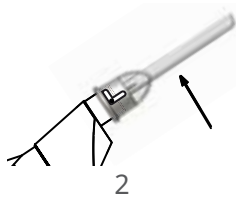
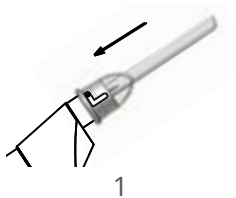

Ref. 200 157 : NV KAVO DB

KAVO E

Adaptateur sans joint
Adapter without any O-ring

Déclipser l'embout d'origine de la seringue.
Unclip the original tip of the syringe.

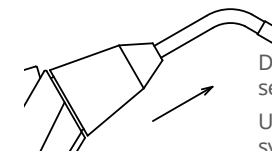

Vérifier que l'anneau en métal (le clip) est en bon état.
Check that the metal ring (the clip) is undamaged.

Lubrifier la seringue, dévisser la petite vis, clipser l'adaptateur sur la seringue en le tournant et revisser la petite vis.
Lubricate the syringe, unscrew the small screw, clip the adapter on the syringe while turning it, and screw again the small screw.

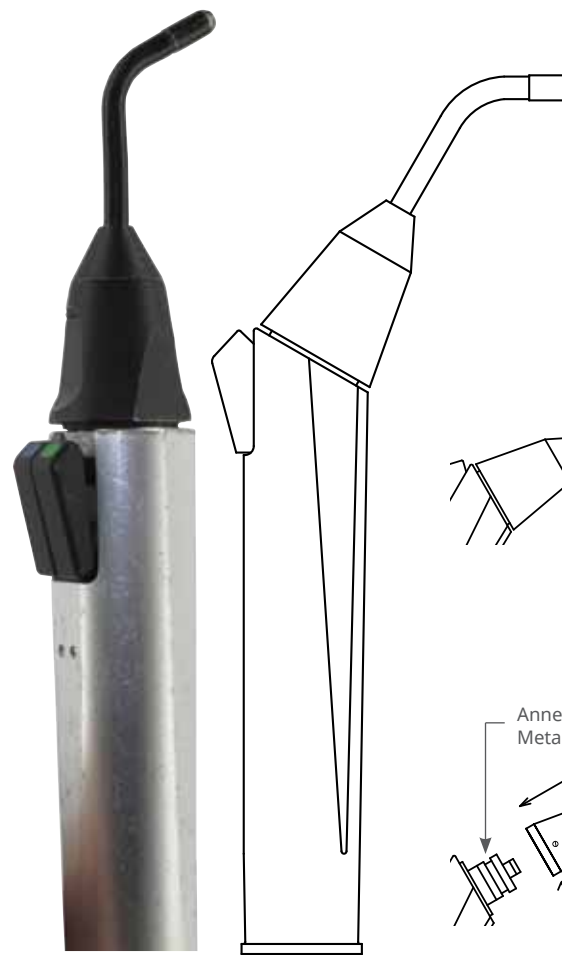
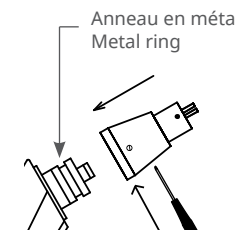

Pour seringues/For syringes
KAVO ESTETICA
n° 5730520 - n° 5730530

Mettre en place l'embout jetable.
Insert the disposable tip.

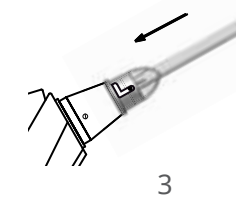
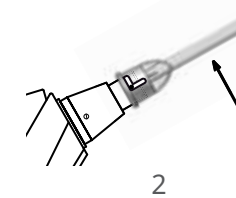
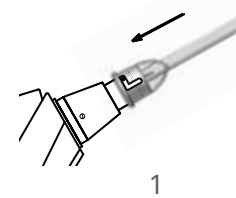

Ref. 200 172 : NV KAVO E



KAVO GB

Adaptateur sans joint
Adapter without O-ring

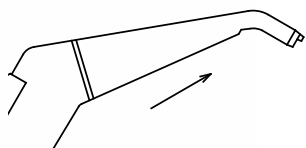

Déclipser l'embout d'origine de la seringue.
Unclip the original tip of the syringe.

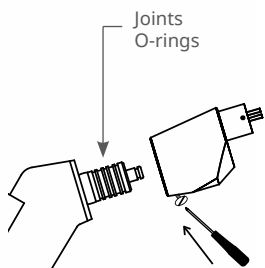

Vérifier que les joints de la seringue sont en bon état.
Check that the O-rings of the syringe are undamaged.

Lubrifier la seringue, dévisser la petite vis, clipser l'adaptateur sur la seringue en le tournant et revisser la petite vis.
Lubricate the syringe, unscrew the small screw, clip the adapter on the syringe while turning it and screw again the small screw.

Lubrifier la seringue, dévisser la petite vis, clipser l'adaptateur sur la seringue en le tournant et revisser la petite vis.
Lubricate the syringe, unscrew the small screw, clip the adapter on the syringe while turning it and screw again the small screw.

Lubrifier la seringue, dévisser la petite vis, clipser l'adaptateur sur la seringue en le tournant et revisser la petite vis.
Lubricate the syringe, unscrew the small screw, clip the adapter on the syringe while turning it and screw again the small screw.

Mettre en place l'embout jetable.
Insert the disposable tip.

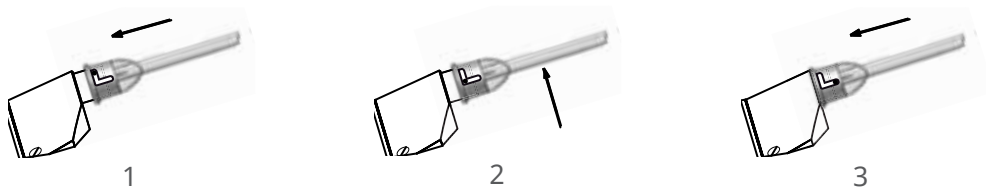

Ref. 200 156 : NV KAVO GB



KAVO HB

Adaptateur sans joint
Adapter without any O-ring

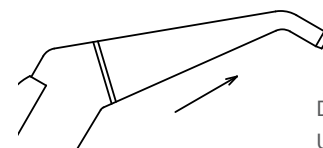

Déclipser l'embout d'origine de la seringue.
Unclip the original tip of the syringe.

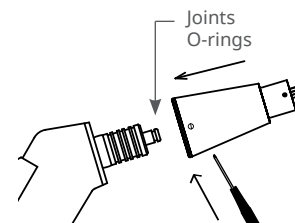

Vérifier que les joints de la seringue sont en bon état.
Check that the O-rings of the syringe are undamaged.

Lubrifier la seringue, dévisser la petite vis, clipser l'adaptateur sur la seringue en le tournant et revisser la petite vis.
Lubricate the syringe, unscrew the small screw, clip the adapter on the syringe while turning it and screw again the small screw.

Lubrifier la seringue, dévisser la petite vis, clipser l'adaptateur sur la seringue en le tournant et revisser la petite vis.
Lubricate the syringe, unscrew the small screw, clip the adapter on the syringe while turning it and screw again the small screw.

Lubrifier la seringue, dévisser la petite vis, clipser l'adaptateur sur la seringue en le tournant et revisser la petite vis.
Lubricate the syringe, unscrew the small screw, clip the adapter on the syringe while turning it and screw again the small screw.

Pour seringues/For syringes
KAVO
n° 7730500 - n° 7730510

Mettre en place l'embout jetable.
Insert the disposable tip.

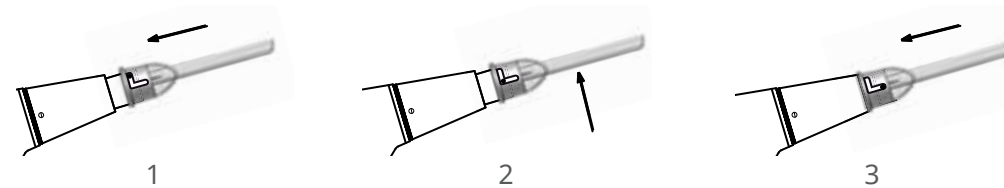

Ref. 200 153 : NV KAVO HB

KAVO IB

Adaptateur avec 3 joints
Adapter with 3 O-rings

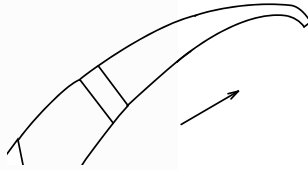

Déclipser l'embout d'origine de la seringue.
Unclip the original tip of the syringe.

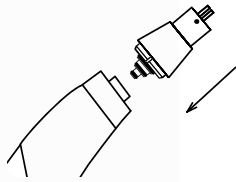

Lubrifier les joints de l'adaptateur et clipser l'adaptateur sur la seringue en le tournant.
Lubricate the O-rings of the adapter. Clip the adapter on the syringe while turning it.

Mettre en place l'embout jetable.
Insert the disposable tip.

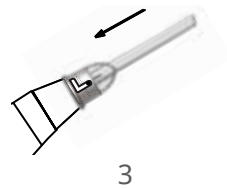
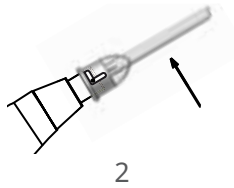
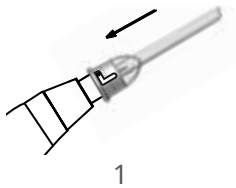

 Ref. 200 192 : NV KAVO IB

KAVO J

Adaptateur avec 1 joint
Adapter with 1 O-ring

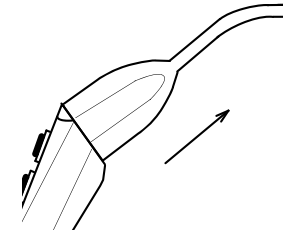

Déclipser l'embout d'origine de la seringue.
Unclip the original tip of the syringe.

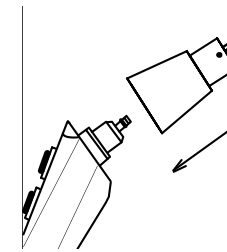

Lubrifier le joint de la seringue et clipser l'adaptateur sur la seringue en le tournant.
Lubricate the O-ring of the syringe, clip the adapter on the syringe while turning it.

Mettre en place l'embout jetable.
Insert the disposable tip.

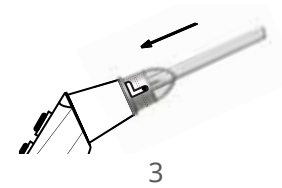
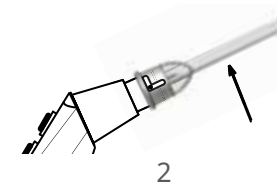
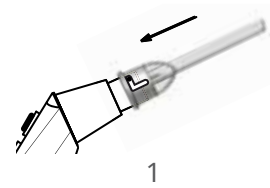

 Ref. 200 181 : NV KAVO J

KAVO K

Adaptateur avec 2 joints
Adapter with 2 O-rings

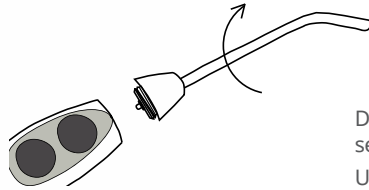

Dévisser l'embout d'origine de la seringue.
Unscrew the original tip of the syringe.

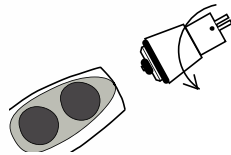

Lubrifier les 2 joints de l'adaptateur et le visser sur la seringue.
Lubricate the 2 O-rings of the adapter and screw it on the syringe.

Mettre en place l'embout jetable.
Insert the disposable tip.

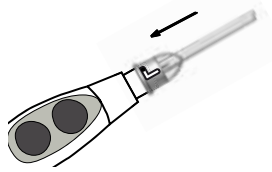

1

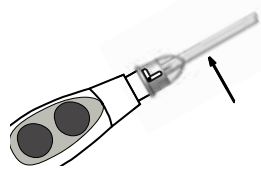

2

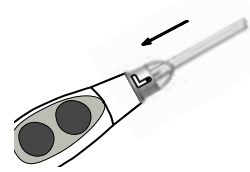

3



Ref. 200 160 : NV KAVO K

LU INOX

Adaptateur sans joint
Adapter without any O-ring

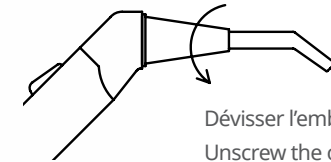
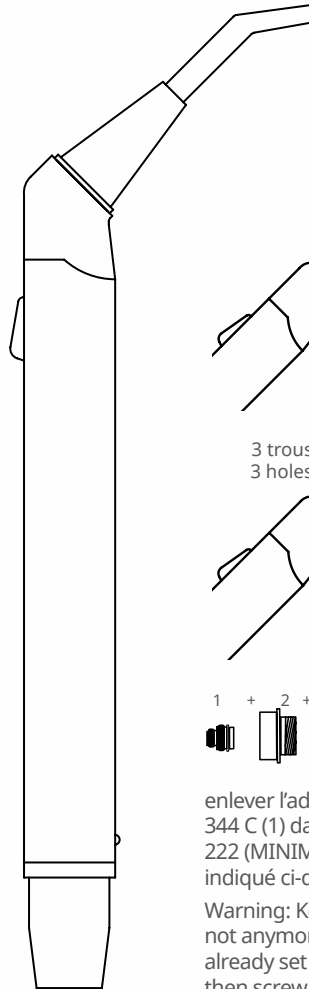

Dévisser l'embout d'origine de la seringue.
Unscrew the original tip of the syringe.

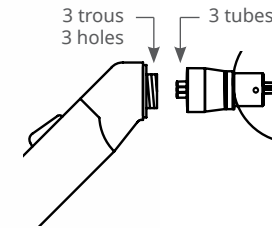

3 trous
3 holes

3 tubes

Mettre les 3 tubes de l'adaptateur dans les 3 trous de la seringue et visser l'adaptateur.
Put the 3 tubes of the adapter into the 3 holes of the syringe and screw the adapter.

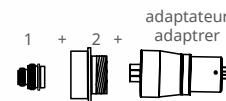

1

+

2

+

adaptateur
adaptrr

Attention : Garder la seringue montée sur le cordon. Si votre seringue n'est plus équipée de l'embout d'origine, enlever l'adaptateur déjà monté sur la seringue. Enfoncer la pièce 344 C (1) dans la seringue, puis visser la pièce 447 (2) ou la pièce 222 (MINIMATE). Mettre en place l'adaptateur LU INOX comme indiqué ci-dessus.

Warning: Keep the complete syringe on the flex. If your syringe is not anymore equipped with the original tip, remove the adapter already set on the syringe. Push (1) part 344 C inside the syringe, then screw (2) part 447 or part 222 (MINIMATE). Set the adapter LU INOX in position as indicated above.

Mettre en place l'embout jetable.
Insert the disposable tip.

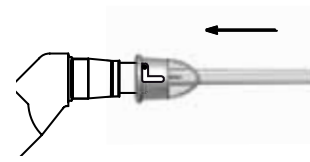

1

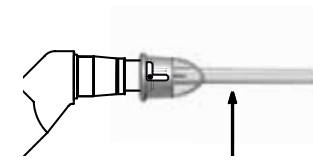

2

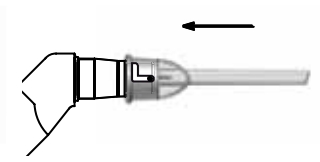

3



Ref. 200 150 : NV LU INOX - Ref. 203 969 : PIECE 447 - Ref. 203 960 :
PIECE 344C - Ref. 203 976 : PIECE 222

LU V

Adaptateur avec 2 joints
Adapter with 2 O-rings

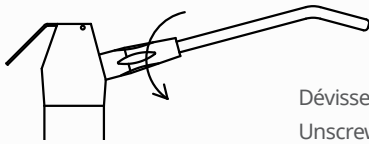

Dévisser l'embout d'origine de la seringue.
Unscrew the original tip of the syringe.

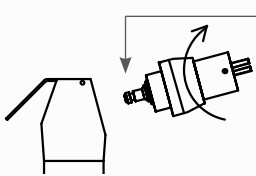

Vérifier que le petit joint est au bout de l'adaptateur.
Check that the small O-ring is at the end of the adapter.
Lubrifier les joints et visser l'adaptateur.
Lubricate the O-rings and screw the adapter.

Mettre en place l'embout jetable.
Insert the disposable tip.

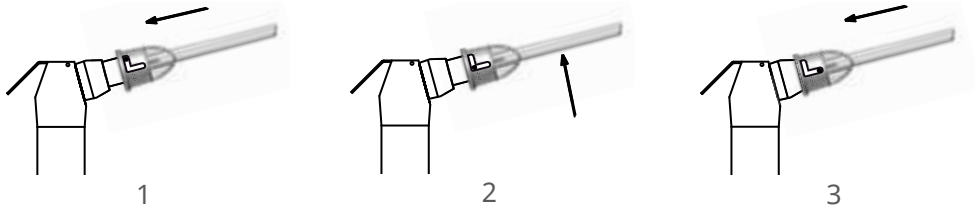

Ref. 200 173 : NV LU V

LU NEW INOX

Adaptateur sans joint
Adapter without O-ring

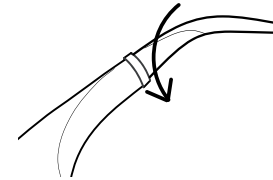

Dévisser l'embout d'origine de la seringue au niveau de la bague en métal.
Unscrew the original tip of the syringe at the metal ring level.

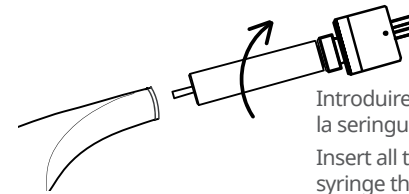

Introduire complètement l'adaptateur dans la seringue et le visser.
Insert all the way the adapter inside the syringe then screw it.

Mettre en place l'embout jetable.
Insert the disposable tip.

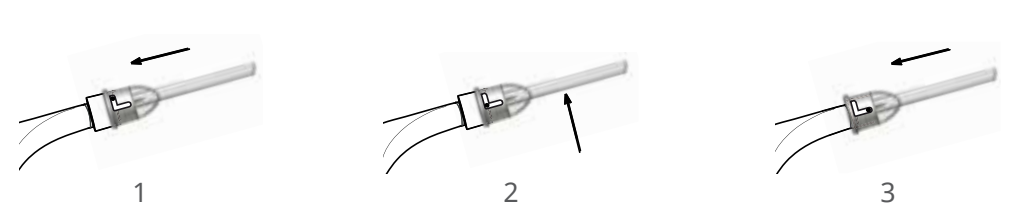

Ref. 200 199 : NV LU NEW INOX

MORITA 66 TYPE 2

Adaptateur avec 2 joints
Adapter with 2 O-rings

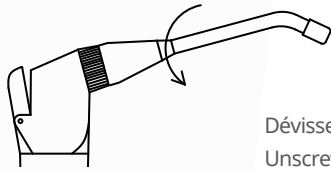

Dévisser l'embout d'origine de la seringue.
Unscrew the original tip of the syringe.

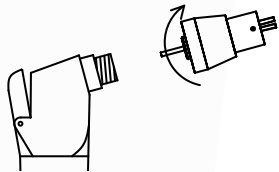

Lubrifier les 2 joints et la partie de l'adaptateur rentrant dans la seringue et visser l'adaptateur.
Lubricate the 2 O-rings and the part of the adapter going inside the syringe and screw the adapter.

Mettre en place l'embout jetable.
Insert the disposable tip.

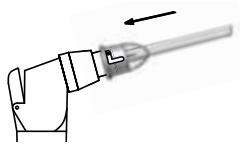

1

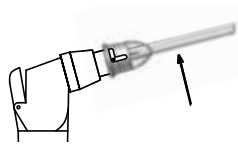

2

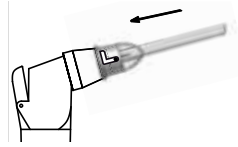

3



Ref. 200 159 : NV MORITA 66 TYPE 2

MORITA S12

Adaptateur avec 2 joints
Adapter with 2 O-rings

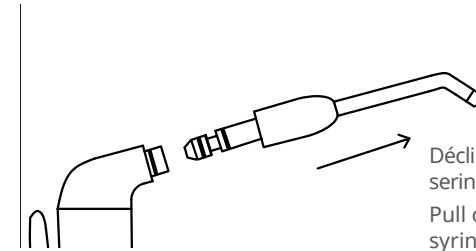

Déclipser l'embout d'origine de la seringue en tirant.
Pull on the original tip of the syringe to unclip it.

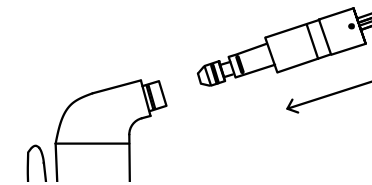

Lubrifier les 2 joints de l'adaptateur et clipser le sur la seringue.
Lubricate the 2 O-rings of the adapter then clip it on the syringe.

Mettre en place l'embout jetable.
Insert the disposable tip.

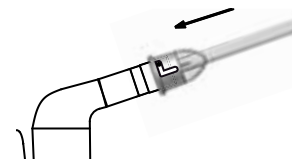

1

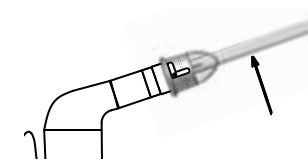

2

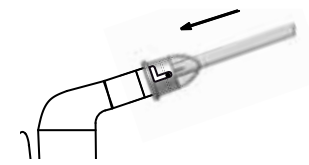

3



Ref. 200 183 : NV MORITA S12

MORITA INOX WS10

Adaptateur sans joint
Adapter without any O-ring

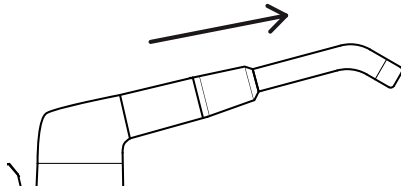

Appuyer sur le bouton de la seringue et enlever l'embout d'origine en le tirant.
Press the button on the syringe and remove the original tip by pulling it.

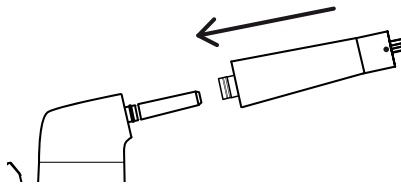

Appuyer sur le bouton de la seringue et mettre en place l'adaptateur comme indiqué sur le dessin.
Press the button on the syringe and set up the adapter as shown in the drawing.

Mettre en place l'embout jetable.
Insert the disposable tip.

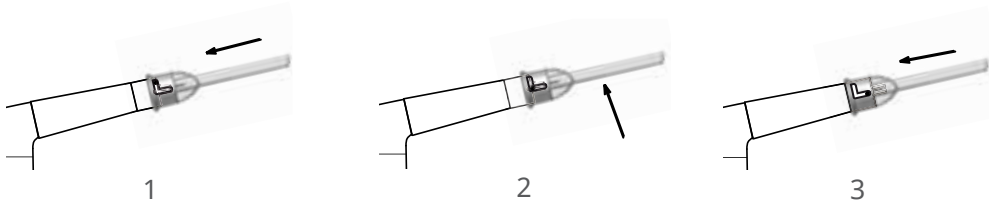

 Ref. 200 201 : NV MORITA INOX WS10

MORITA INOX WS97

Adaptateur sans joint
Adapter without any O-ring

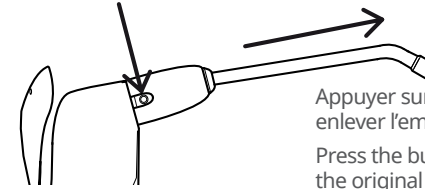

Appuyer sur le bouton de la seringue et enlever l'embout d'origine en le tirant.
Press the button on the syringe and remove the original tip by pulling it.

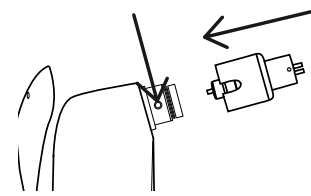

Appuyer sur le bouton de la seringue et mettre en place l'adaptateur comme indiqué sur le dessin.
Press the button on the syringe and set up the adapter as shown in the drawing.

Mettre en place l'embout jetable.
Insert the disposable tip.

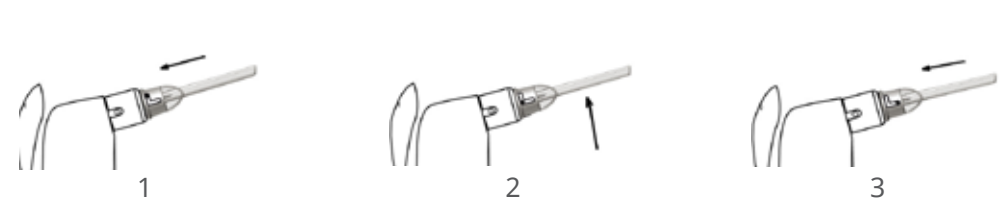

 Ref. 200 200 : NV MORITA INOX WS97

RITTER COMBIJET

Adaptateur sans joint
Adapter without any O-ring

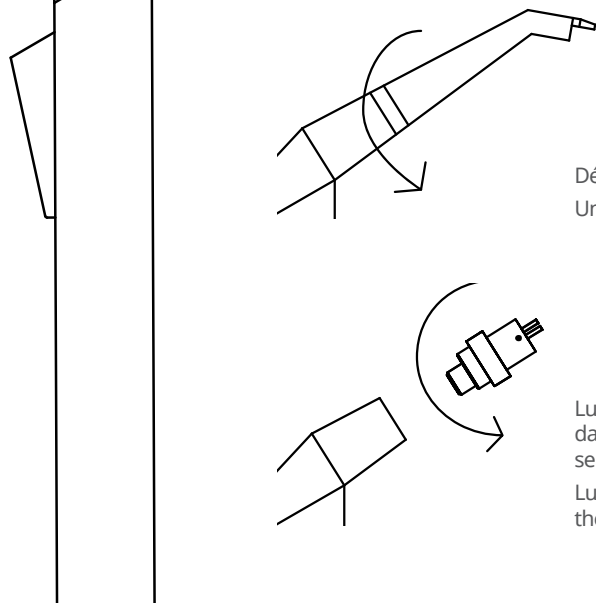

Dévisser l'embout d'origine de la seringue.
Unscrew the original tip of the syringe.

Lubrifier la partie de l'adaptateur rentrant dans la seringue avant de le visser sur la seringue.
Lubricate the part of the adapter going inside the syringe before screwing it on the syringe.

Mettre en place l'embout jetable.
Insert the disposable tip.

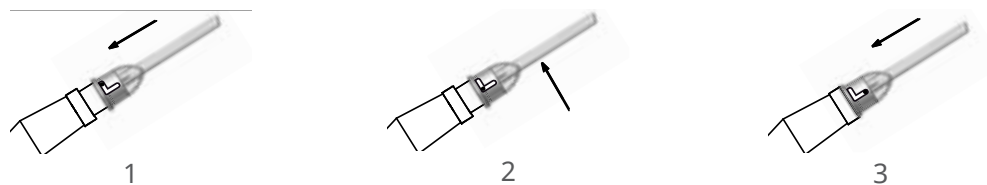

 Ref. 200 175 : NV RITTER COMBIJET

RITTER TOPJET

Adaptateur avec 2 joints
Adapter with 2 O-rings



Déclipser l'embout d'origine de la seringue.
Unclip the original tip of the syringe.

Lubrifier les 2 joints et clipser l'adaptateur en le tournant.
Lubricate the 2 O-rings and clip the adapter while turning it.

Mettre en place l'embout jetable.
Insert the disposable tip.

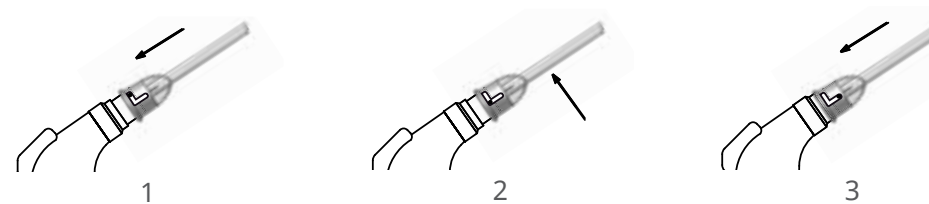

 Ref. 200 176 : NV RITTER TOPJET

SIEMENS 2000

Adaptateur avec 2 joints
Adapter with 2 O-rings

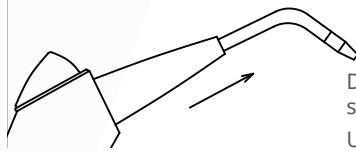

Déclipser l'embout d'origine de la seringue.
Unclip the original tip of the syringe.

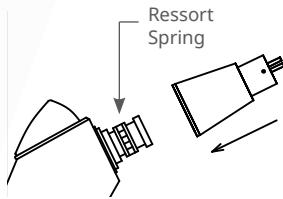

Vérifier que le ressort en métal (le clip) est en bon état.
Check that the metal spring (the clip) is undamaged.
Lubrifier la seringue et clipser l'adaptateur en tournant.
Lubricate the syringe and clip the adapter while turning it.

Mettre en place l'embout jetable.
Insert the disposable tip.

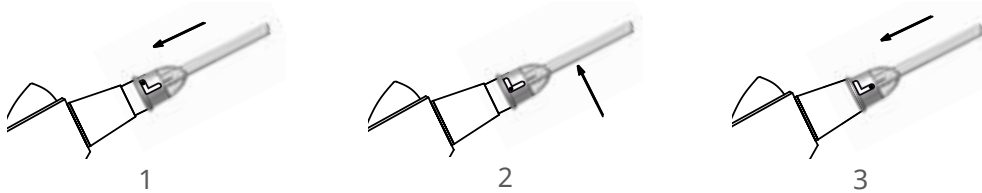

 Ref. 200 177 : NV SIEMENS 2000

SIEMENS 4000

Adaptateur avec 2 joints
Adapter with 2 O-rings

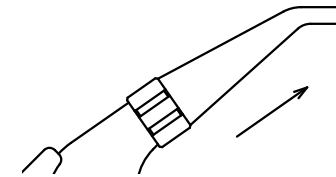

Déclipser l'embout d'origine de la seringue.
Unclip the original tip of the syringe.

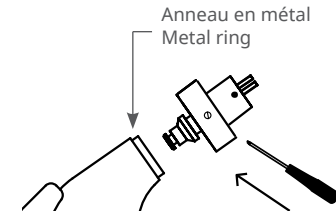

Vérifier que le ressort en métal (le clip) est en bon état.
Check that the metal spring (the clip) is undamaged.
Dévisser la petite vis, lubrifier les 2 joints, enfoncer l'adaptateur dans la seringue en tournant jusqu'à audition d'un clic et revisser la petite vis.
Unscrew the small screw, lubricate the 2 O-rings, push the adapter in the syringe while turning until you hear a clic and screw again the small screw.

Mettre en place l'embout jetable.
Insert the disposable tip.

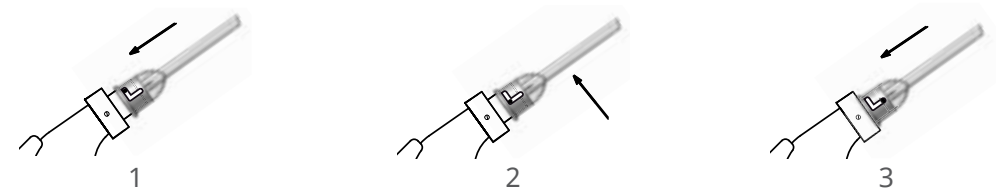

 Ref. 200 178 : NV SIEMENS 4000

SIEMENS E

Adaptateur avec 2 joints
Adapter with 2 O-rings

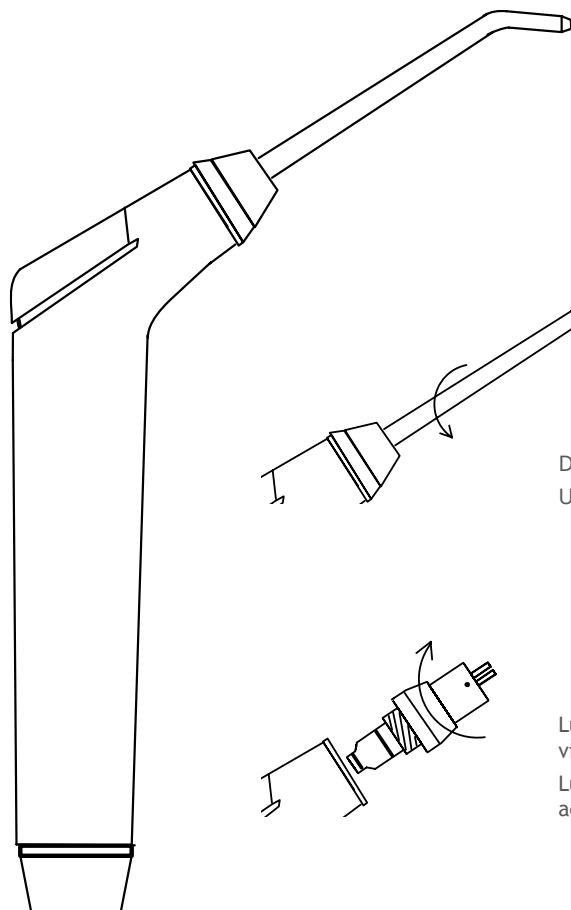

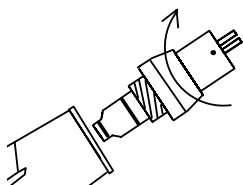

Déclipser l'embout d'origine de la seringue.
Unclip the original tip of the syringe.

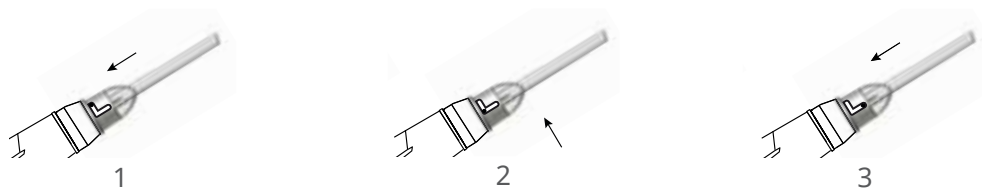

Lubrifier les 2 joints de l'adaptateur puis visser l'adaptateur sur la seringue.
Lubricate the 2 O-rings then screw the adapter on the syringe.

Mettre en place l'embout jetable.
Insert the disposable tip.



 Ref. 200 179 : NV SIEMENS E

SIRONA B

Adaptateur avec 3 joints
Adapter with 3 O-rings



Déclipser l'embout d'origine de la seringue.
Unclip the original tip of the syringe.

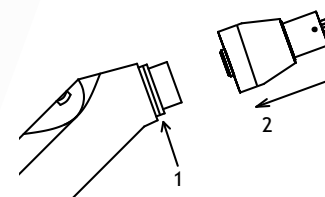

1. Vérifier que la bague en métal est en bon état (1).
2. Lubrifier les 3 joints et clipser l'adaptateur en tournant (2). Si vous avez un problème pour clipser votre adaptateur, vous devez changer la bague en métal de la seringue.

1. Check the good shape of the metal ring (1).
2. Lubricate the 3 O-rings and clip the adapter while turning (2). If you have a problem to clip it, you must change the metal ring of the syringe.

Mettre en place l'embout jetable.
Insert the disposable tip.

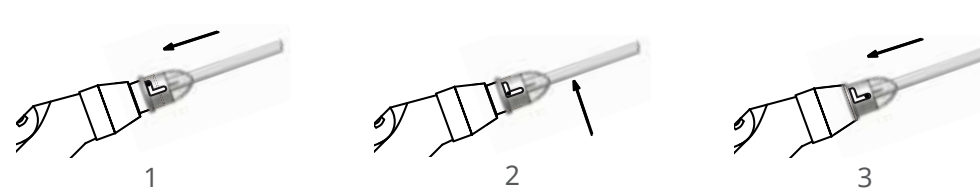

 Ref. 200 154 : NV SIRONA B

SIRONA L

Adaptateur avec 3 joints
Adapter with 3 O-rings



Déclipser l'embout d'origine de la seringue.
Unclip the original tip of the syringe.

Vérifier que la bague en métal est en bon état (1). Lubrifier les 3 joints et clipser l'adaptateur en tournant (2).
Si vous avez un problème pour clipser l'adaptateur, vous devez changer la bague en métal de la seringue.
Check the good condition of the metal ring (1). Lubricate the 3 O-rings and clip the adapter while turning (2).
If you have a problem to clip it, you must change the metal ring of the syringe.

Mettre en place l'embout jetable.
Insert the disposable tip.

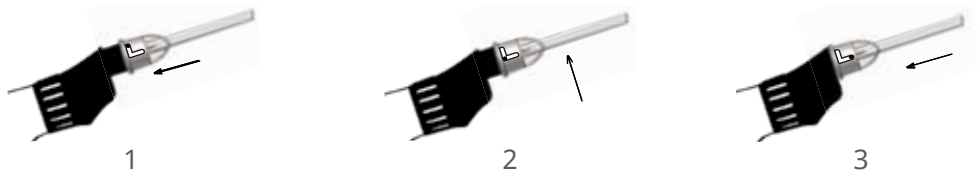

 Ref. 200 196 : NV SIRONA L

STERN WEBER

Adaptateur avec 3 joints
Adapter with 3 O-rings

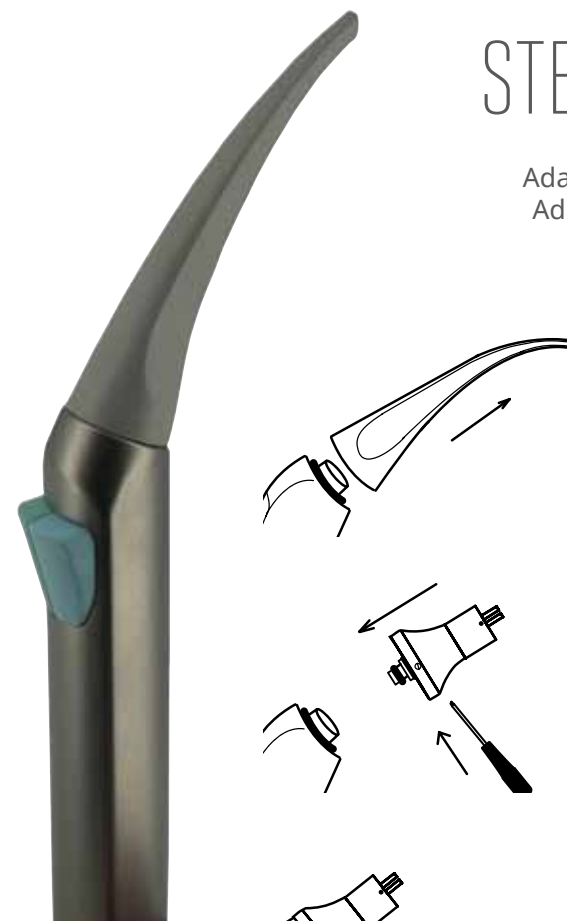

Enlever délicatement l'embout d'origine de la seringue en le tirant.
Remove softly the original tip from the syringe by pulling it.

Lubrifier les joints de l'adaptateur, dévisser la petite vis, clipser l'adaptateur sur la seringue en le tournant.
Lubricate the O-rings of the adapter, unscrew the small screw, clip the adapter onto the syringe while turning.

Visser la vis de l'adaptateur.
Screw the screw located on the adapter.

Mettre en place l'embout jetable.
Insert the disposable tip.

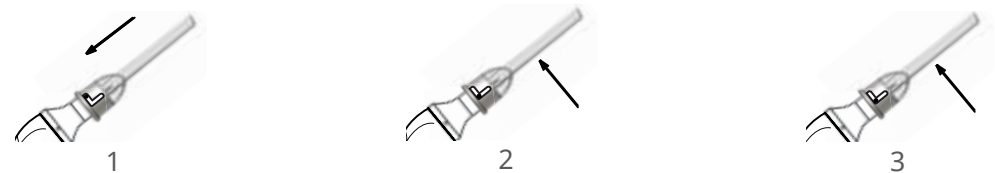

 Ref. 200 197 : NV CEFLA INOX

STERN WEBER

Adaptateur avec 2 joints
Adapter with 2 O-rings

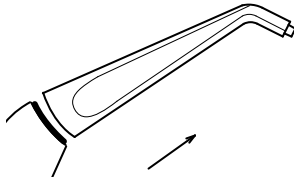

Enlever délicatement l'embout d'origine de la seringue en le tirant.
Remove softly the original tip from the syringe by pulling it.

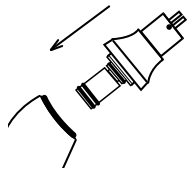

Lubrifier les joints de l'adaptateur, clipser l'adaptateur sur la seringue en le tournant.
Lubricate the O-rings of the adapter, clip the adapter onto the syringe while turning it.

Mettre en place l'embout jetable.
Insert the disposable tip.

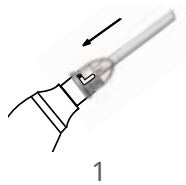

1

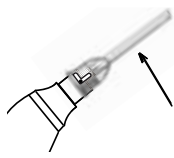

2



3



Ref. 200 198 : NV CAS INOX

TRIDAC II

Adaptateur avec 2 joints
Adapter with 2 O-rings

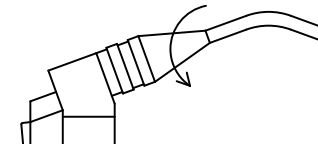
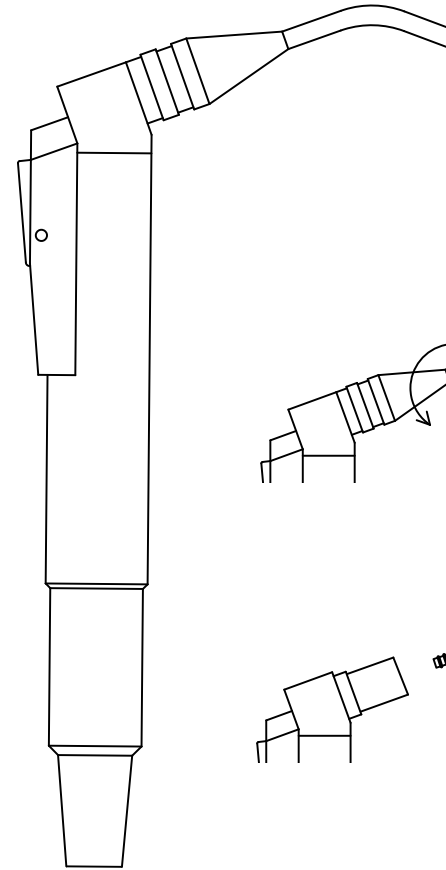

Dévisser l'embout d'origine de la seringue.
Unscrew the original tip of the syringe.

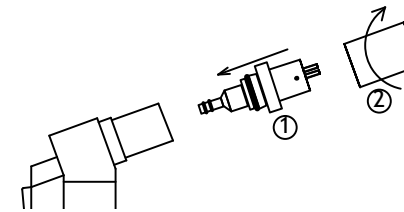

Lubrifier les joints de la partie n° 1 et l'enfoncer dans la seringue, puis visser la partie n° 2.

Lubricate the O-rings from the part n°1 and push it inside the syringe, then screw part n°2.

Mettre en place l'embout jetable.
Insert the disposable tip.

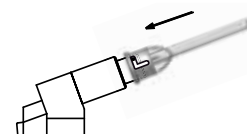

1

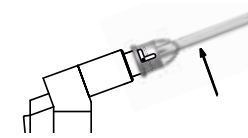

2

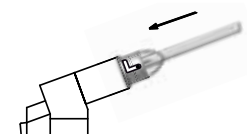

3



Ref. 200 190 : NV TRIDAC II

YOSHIDA 3

Adaptateur avec 3 joints
Adapter with 3 O-rings

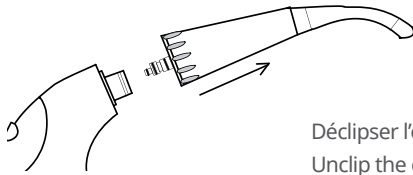
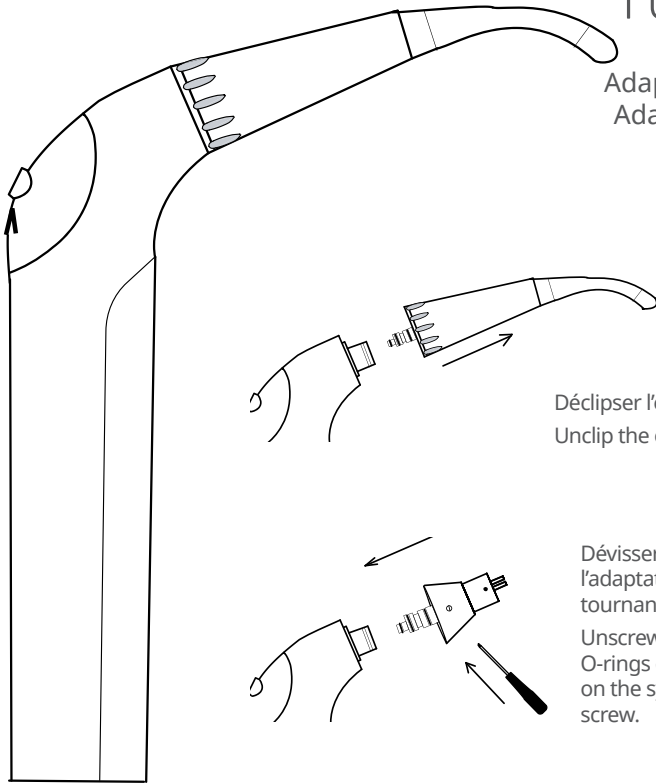

Déclipser l'embout d'origine de la seringue.
Unclip the original tip of the syringe.

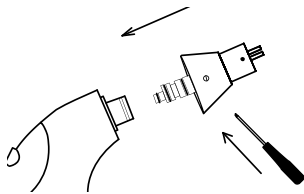

Dévisser la petite vis, lubrifier le joint de l'adaptateur, clipser l'adaptateur en le tournant et revisser la petite vis.

Unscrew the small screw, lubricate the O-rings of the adapter, clip the adapter on the syringe and then screw the small screw.

Mettre en place l'embout jetable.
Insert the disposable tip.

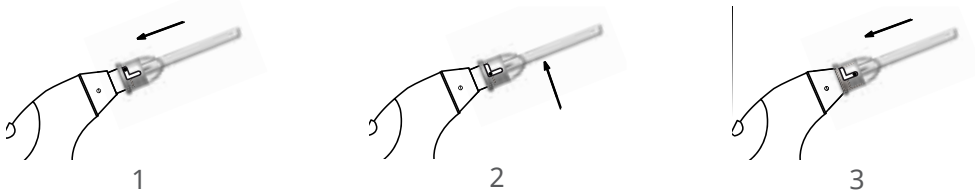

 Ref. 200 193 : NV YOSHIDA 3

YOSHIDA V

Adaptateur sans joint
Adapter without any O-ring

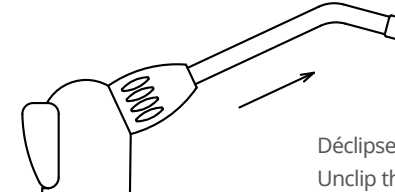
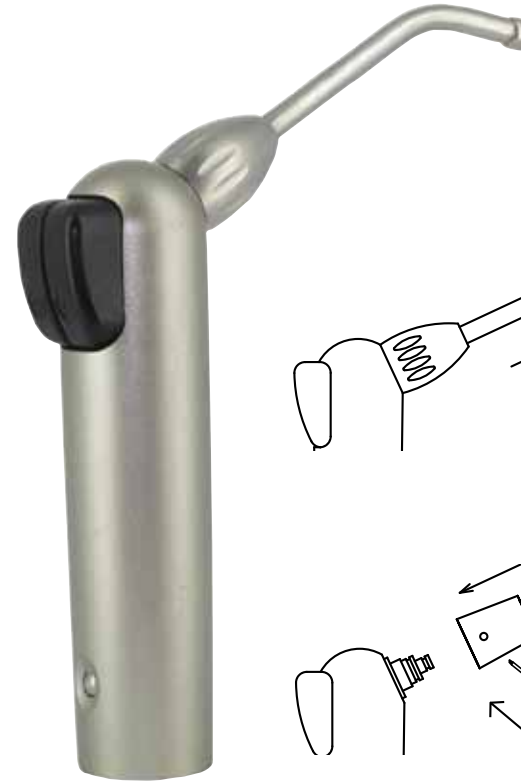

Déclipser l'embout d'origine de la seringue.
Unclip the original tip of the syringe.

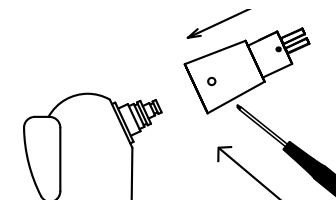

Lubrifier la seringue, dévisser la petite vis de l'adaptateur puis clipser l'adaptateur sur la seringue en le tournant et revisser la petite vis.

Lubricate the syringe, unscrew the small screw of the adapter then clip the adapter on the syringe while turning it and screw again the small screw.

Mettre en place l'embout jetable.
Insert the disposable tip.

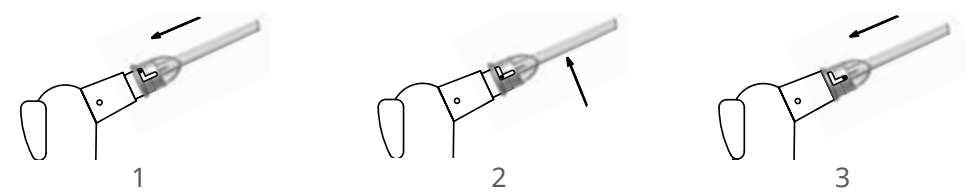

 Ref. 200 180 : NV YOSHIDA V

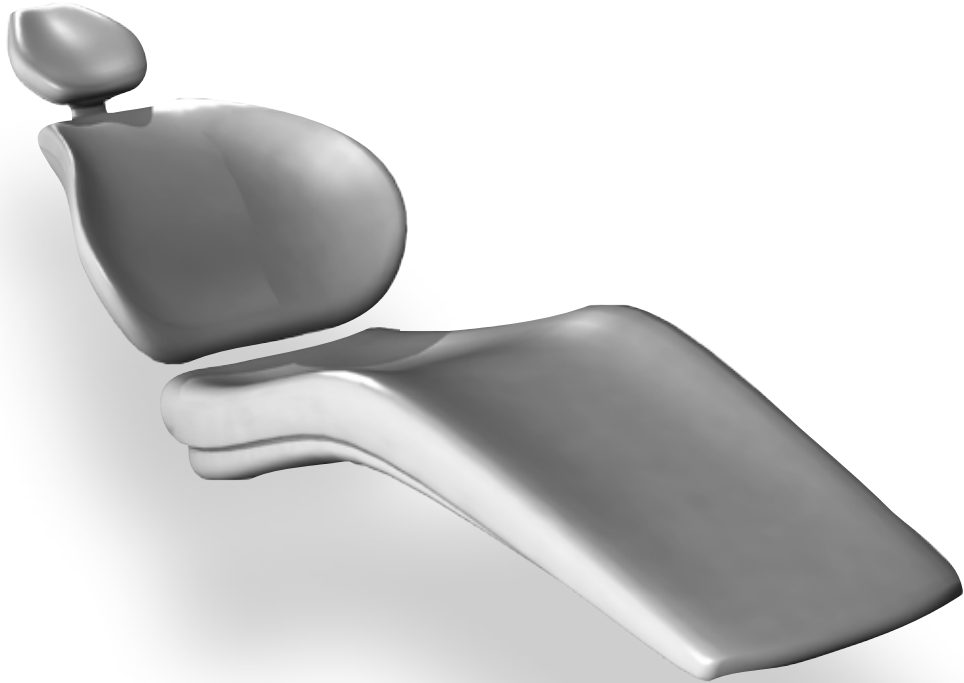

3

RÉCAPITULATIF DES MARQUES
DE FAUTEUILS, SERINGUES
ET ADAPTATEURS CORRESPONDANTS

SUMMARY OF UNITS AND SYRINGES
BRANDS AND CORRESPONDING
ADAPTERS

Fauteuil / Unit	Modèle / Type	Seringue / Syringe	Adaptateur / Adapter	Réf. / Ref.
ADEC		Adec	NV Adec Inox	200195
A.D.M. Select Dental		Faro*	NV FA C ou/or NV FA C2	200167 200168
AIRCAR		Luzzani*	NV LU Inox	200150
AIREL		Faro*	NV FA C ou/or NV FA C2 ou/or NV FA S1	200167 200168 200182
		Luzzani*	NV LU Inox	200150
		Mini Bright	NV LU New Inox	200199
AJAX		Copie/Copy DCI	NV DCI	200152
		Copie/Copy Adec	NV Adec Inox	200195
AMPCO DENTAL		DCI	NV DCI	200152
ANATOM		Ritter	NV Ritter Topjet	200176
		Luzzani*	NV LU Inox	200150
ANCAR		Luzzani*	NV LU Inox	200150
ANTHOS		Luzzani*	NV LU Inox	200150
		Faro*	NV FA S1	200182
		Faro*	NV FA E	200165
		Anthos	NV Cefla Inox	200197
		Nlle/New Cefla	NV Cas Inox	200198
ASISTROM		Luzzani*	NV LU Inox	200150
AS GOLD		DCI	NV DCI	200152
ASEPTICO		Adec	NV Adec Inox	200195
		Forest	NV Adec Inox	200195
B-PRODUCTION		Copie/Copy DCI	NV DCI	200152
BEAVER DENTAL		Adec	NV Adec Inox	200195

*Faro et Luzzani ne sont pas des marques déposées par Produits Dentaires Pierre Rolland (groupe Acteon)
*Faro and Luzzani are not trademarks of Produits Dentaires Pierre Rolland (Acteon group)

Fauteuil / Unit	Modèle / Type	Seringue / Syringe	Adaptateur / Adapter	Réf. / Ref.
BELMONT		Belmont	NV Belmont New	200158
		Faro*	NV FA C ou/or NV FA C2	200167 200168
		Adec	NV Adex Inox	200195
		Luzzani*	NV LU Inox	200150
		DCI	NV DCI	200152
BIODENTAL		Faro*	NV FA C ou/or NV FA C2	200167 200168
BRAVO 21C		DCI	NV DCI	200152
BROXDENT		DCI	NV DCI	200152
CACCAN		Forest	NV Adec Inox	200195
		Faro*	NV FA C ou/or NV FA C2	200167 200168
		Luzzani*	NV LU Inox	200150
CANCAN		DCI	NV DCI	200152
CASMON		Copie/Copy DCI	NV DCI	200152
CASTELLINI	SKEMA CLEAN WARM 2	Castellini	NV Castellini V	200163
	LOGOS	Castellini	NV Castellini Logo New	200184
	PUMA,PUMA+ Threesteril LOGOS Junior	Castellini Logo boutons ronds Logo round buttons	NV Castellini Logo New	200184
	LOGOS Junior, Duo	Avec lumière With light	NV Cefla Inox	200197
		Nlle/New Cefla	NV Cas Inox	200198

*Faro et Luzzani ne sont pas des marques déposées par Produits Dentaires Pierre Rolland (groupe Acteon)
*Faro and Luzzani are not trademarks of Produits Dentaires Pierre Rolland (Acteon group)

Fauteuil / Unit	Modèle / Type	Seringue / Syringe	Adaptateur / Adapter	Réf. / Ref.
CEMM BOLOGNA		Luzzani*	NV LU Inox	200150
		Luzzani* (anciens modèles / old types)	NV Lu Inox + Piece 447/Part447	200150 203969
		Cemm	NV Cefla Inox	200197
		Nlle/New Cefla	NV Cas Inox	200198
CHAYES		Adec	NV Adex Inox	200195
CHIRADENT		Luzzani*	NV LU Inox	200150
		Luzzani*	NV LU V	200173
CHIRANA	S1	Faro*	NV FA S1	200182
		Luzzani*	NV LU Inox	200150
CHIROMEGA		Copie/Copy DCI	NV DCI	200152
CONFIDENT		Luzzani*	NV LU Inox	200150
COPEGA		Luzzani*	NV LU Inox	200150
CORE DEEP		Copie/Copy DCI	NV DCI	200152
3 D		Adec	NV Adex Inox	200195
		Luzzani*	NV LU Inox	200150
DABI ATLANTE		DCI	NV DCI	200152
		Copie/Copy DCI	NV DCI	200152
DetA CLINIC	HELIX	Faro*	NV FA C ou/or NV FA C2	200167 200168
D.B.I.		D.B.I.	NV Adex Inox	200195
		Copie/Copy DCI	NV DCI	200152
DCI	Ancien modèle/ Old type	Siemens/Sirona	NV Siemens 2000	200177
		DCI	NV DCI	200152

*Faro et Luzzani ne sont pas des marques déposées par Produits Dentaires Pierre Rolland (groupe Acteon)
*Faro and Luzzani are not trademarks of Produits Dentaires Pierre Rolland (Acteon group)

Fauteuil / Unit	Modèle / Type	Seringue / Syringe	Adaptateur / Adapter	Réf. / Ref.
DENIMED (Argentine)		Luzzani*	NV LU Inox	200150
		Copie/Copy DCI	NV DCI	200152
DENPEX ET SURPLUS		Luzzani*	NV LU V	200173
		Luzzani*	NV LU Inox	200150
DENTAL ACTION		Copie/Copy DCI	NV DCI	200152
DENTAL BERDEL		Adec	NV Adec Inox	200195
DENTAL ERGONOMICS		Faro*	NV FA S1	200182
		Luzzani*	NV LU Inox	200150
DENTALEZ	Ancien modèle/ Old type	Adec	NV Adec Inox	200195
		Dentalez	NV Dentalez	200164
	Nouveau modèle/ New type	DCI	NV DCI	200152
		Copie/Copy DCI	NV DCI	200152
DENTAL INTERNATIONAL		Faro*	NV FA C ou/or NV FA C2	200167 200168
			Luzzani*	NV LU Inox
DENTECH		DCI	NV DCI	200152
DENTMARK		Copie/Copy DCI	NV DCI	200152
		Luzzani*	NV LU Inox	200150
DENT SAN (Turquie)		Copie/Copy DCI	NV DCI	200152
		Luzzani*	NV LU Inox	200150
DIGIX		Luzzani*	NV LU Inox	200150
DIPLOMAT		Luzzani*	NV LU Inox	200150
		Luzzani*	NV LU V	200173

*Faro et Luzzani ne sont pas des marques déposées par Produits Dentaires Pierre Rolland (groupe Acteon)
*Faro and Luzzani are not trademarks of Produits Dentaires Pierre Rolland (Acteon group)

Fauteuil / Unit	Modèle / Type	Seringue / Syringe	Adaptateur / Adapter	Réf. / Ref.
D K L		DCI	NV DCI	200152
		Luzzani*	NV LU Inox	200150
	Nouveau modèle/ New type	MiniBright	NV LU New Inox	200199
DRILLCO		Copie/Copy DCI	NV DCI	200152
D.S. DENTAL		DCI	NV DCI	200152
		Adec	NV Adec Inox	200195
D-TEC AB		DCI	NV DCI	200152
ECODENT		Faro*	NV FA C ou/or NV FA C2	200167 200168
		Luzzani*	NV LU Inox	200150
EGNER		Luzzani*	NV LU Inox	200150
EMBRA		Luzzani*	NV LU Inox	200150
EMDA		Faro*	NV FA E2	200166
ENGLE		Engle	NV Engle	200194
E.T.I.		DCI	NV DCI	200152
EUROCAD		Luzzani*	NV LU Inox	200150
EURODENT		Luzzani*	NV LU Inox	200150
		Faro*	NV FA C ou/or NV FA C2	200167 200168
EURO-MED (Chirana Dental)	Diplomat	Luzzani*	NV LU Inox	200150
		Faro*	NV FA C ou/or NV FA C2	200167 200168
		Faro*	NV FA S1	200182
		Luzzani*	NV LU V	200173
EUROSTAR		Luzzani*	NV LU Inox	200150
FAMED		Luzzani*	NV LU Inox	200150

*Faro et Luzzani ne sont pas des marques déposées par Produits Dentaires Pierre Rolland (groupe Acteon)
*Faro and Luzzani are not trademarks of Produits Dentaires Pierre Rolland (Acteon group)

Fauteuil / Unit	Modèle / Type	Seringue / Syringe	Adaptateur / Adapter	Réf. / Ref.
FARO*	Ancien modèle/ Old type	Faro*	NV FA E2	200166
			Faro* Electronic	NV FA E
		Faro* SR3, SR6	NV FA C	200167
		Faro* S903. S906 avec clip ou bouton with clip or button	NF FA C2	200168
		Faro*	NV FA S1	200182
FEDESA	Ronda Lux	Luzzani*	NV LU Inox	200150
	Midway Air	Adec	NV Adex Inox	200195
	Carisma, Astral	Faro*	NV FA S1	200182
	Nouveau modèle/ New type	Mini Bright	NV LU New Inox	200199
FIMET		Luzzani*	NV LU Inox	200150
		(Shangai) DCI	NV DCI	200152
		Adec	NV Adec Inox	200195
FINNDENT	Quint	Forest	NV Adex Inox	200195
		Luzzani*	NV LU Inox	200150
		Faro*	NV FA S1	200182
FLEX	Ancien modèle/ Old type	Flex/Delta Goof	NV Flex	200169
			Luzzani*	NV LU Inox
		Nouveau modèle/ New type	DCI	NV DCI
FONA		Copie/Copy DCI	NV DCI	200152
		Siemens/Sirona	NV Sirona B	200154
FOREST		Forest	NV Adec Inox	200195
		Luzzani*	NV LU Inox	200150
		DCI	NV DCI	200152
FOSHAN (Chine)		Faro*	NV FA S1	200182

*Faro et Luzzani ne sont pas des marques déposées par Produits Dentaires Pierre Rolland (groupe Acteon)
*Faro and Luzzani are not trademarks of Produits Dentaires Pierre Rolland (Acteon group)

Fauteuil / Unit	Modèle / Type	Seringue / Syringe	Adaptateur / Adapter	Réf. / Ref.
FUSHION		Copie/Copy DCI	NV DCI	200152
GALIT		Luzzani*	NV LU Inox	200150
		DCI	NV DCI	200152
GALLANT		Luzzani*	NV LU Inox	200150
		Faro*	NV FA S1	200182
GALLUS	Nouveau modèle/ New type	Luzzani*	NV LU Inox	200150
GALBIATI		Luzzani*	NV LU Inox	200150
		Faro*	NV FA C ou/or NV FA C2	200167 200168
GEOMED	Leader 21	DCI	NV DCI	200152
GIGADENT		DCI	NV DCI	200152
		Faro*	NV FA S1	200182
GIRADELLI		Luzzani*	NV LU Inox	200150
GLOWS		Glows	NV DCI	200152
		Glows	NV Belmont New	200158
GRUP		Copie/Copy DCI	NV DCI	200152
GUNEY DIS		Luzzani*	NV LU Inox	200150
		Luzzani*	NV LU V	200173
HALLIM	Gracias - Eclipse	DCI	NV DCI	200152
	Platinum	Luzzani*	NV LU Inox	200150
H. SCHEIN	Empire	Schein (UK)	NV Adec Inox	200195

*Faro et Luzzani ne sont pas des marques déposées par Produits Dentaires Pierre Rolland (groupe Acteon)
*Faro and Luzzani are not trademarks of Produits Dentaires Pierre Rolland (Acteon group)

Fauteuil / Unit	Modèle / Type	Seringue / Syringe	Adaptateur / Adapter	Réf. / Ref.
HEKA DENTAL		Luzzani*	NV LU Inox	200150
	Unic Line	Unic	NV Adec Inox	200195
		Faro*	NV FA C ou/or NV FA C2	200167 200168
	Luzzani Nouveau modèle/ New type	Mini Bright	NV LU New Inox	200199
IDEM/COLIBRI		Faro*	NV FA C ou/or NV FA C2	200167 200168
		Luzzani*	NV LU Inox	200150
		DCI	NV DCI	200152
		Faro*	NV FA S1	200182
ITAL DENT		DCI	NV DCI	200152
JOIN CHAMP		Copie/Copy DCI	NV DCI	200152
JORG AND SOHN		Siemens/Sirona	NV Siemens 4000	200178
KAVO	032 AB etc...	Kavo mondial	NV Kavo C	200171
	Eau froide / Cold water 1057 & 1060 SGT/ DSE	Atlantica n° 5730600 & 5730610 Kavo Systema- tica	NV Kavo DB	200157
	1062	n° 5730620 & 5730630 n° 5730640 & 5730650	NV Kavo DB	200157
	1033 & 1038 & 1040	Kavo Esthetica	NV Kavo E	200172
	1042 & 1050 1065 & 1066R/T	n° 5730520 & 5730530 n° 7730000	NV Kavo GB	200156

*Faro et Luzzani ne sont pas des marques déposées par Produits Dentaires Pierre Rolland (groupe Acteon)
*Faro and Luzzani are not trademarks of Produits Dentaires Pierre Rolland (Acteon group)

Fauteuil / Unit	Modèle / Type	Seringue / Syringe	Adaptateur / Adapter	Réf. / Ref.
KAVO	1080 T/C/G 1066 C/ 1057/1058/ 1060S/T	n° 7730010 n° 7730500	NV Kavo HB	200153
	1063/1065/ 1078 S/ 1080/ 1065T/ 1058TM E80	n° 7730510	NV Kavo IB	200192
	1056T/S (hispanic countries)		NV Kavo J	200181
			NV Kavo K	200160
KENT	Fedesa	Adec	NV Adec Inox	200195
KENTSUN		Copie/Copy DCI	NV DCI	200152
KNIGHT		DCI	NV DCI	200152
KORAI		Copie/Copy DCI	NV DCI	200152
KORO		Copie/Copy DCI	NV DCI	200152
LSM		DCI	NV DCI	200152
		Adec	NV Adec Inox	200195
LUZZANI*	Ancien modèle/ Old type	Luzzani* Mini- Light Assistante	NV LU V	200173
		Luzzani* MiniLight & Minimatic & Minmate	NV LU Inox	200150
	Nouveau modèle/ New type	Mini Bright	NV LU New Inox	200199
La seringue Minimate n'utilise pas l'écrou 447 mais l'écrou 222 (réf. 203976). Minimate syringe uses screw 222 (ref. 203976) instead of screw 447.				
MARUS		MARUS	NV Dentalez	200164
		DCI	NV DCI	200152

*Faro et Luzzani ne sont pas des marques déposées par Produits Dentaires Pierre Rolland (groupe Acteon)
*Faro and Luzzani are not trademarks of Produits Dentaires Pierre Rolland (Acteon group)

Fauteuil / Unit	Modèle / Type	Seringue / Syringe	Adaptateur / Adapter	Réf. / Ref.
M.D.T.	Nouveau modèle/ New type	DCI	NV DCI	200152
MEDICA		Luzzani*	NV LU Inox	200150
MEDI PROGRESS		Copie/Copy DCI	NV DCI	200152
MEYER SUPERDENTA		DCI	NV DCI	200152
		Luzzani*	NV LU Inox	200150
		Faro*	NV FA C2	200168
		Copie/Copy DCI	NV DCI	200152
MIKRODENTA		Copie/Copy DCI	NV DCI	200152
MIDWARK		DCI	NV DCI	200152
		Copie/Copy DCI	NV DCI	200152
MIDWAY		Luzzani*	NV LU Inox	200150
MIGLIONICO		Luzzani*	NV LU Inox	200150
		Mini Bright	NV LU New Inox	200199
MIKRONA		Luzzani*	NV LU Inox	200150
MINERVA		Adec	NV Adec Inox	200195
M.I.S.T		M.I.S.T.	NV Dentalez	200164
MORITA	Signo G 30	Morita WS 66	NV Morita 66	200174
			NV Morita 66 Type 2	200159
	Actus 9000	DCI	NV DCI	200152
		Morita S12	NV Morita S12	200183
	Nouveau modèle/ New type	Morita WS97	NV Morita Inox WS97	200200
	Morita WS10	NV Morita WS10	200201	
MODENI		DCI	NV DCI	200152
MULTILINE	GENIUS	Adec	NV Adec Inox	200195

*Faro et Luzzani ne sont pas des marques déposées par Produits Dentaires Pierre Rolland (groupe Acteon)
*Faro and Luzzani are not trademarks of Produits Dentaires Pierre Rolland (Acteon group)

Fauteuil / Unit	Modèle / Type	Seringue / Syringe	Adaptateur / Adapter	Réf. / Ref.
NEODENT		DCI	NV DCI	200152
		Luzzani*	NV LU Inox	200150
OLSEN	Argentina	Copie/Copy DCI	NV DCI	200152
OLYMPIA		Olympia Pax86	NV Adec Inox	200195
		Belmont	NV Belmont New	200158
OLYMPUS		Luzzani*	NV LU Inox	200150
OMS	Punto/Tempo9	Luzzani*	NV LU Inox	200150
	Tempo 9&10	Luzzani*	NV LU V	200173
	Linea 90 / Linea 100	Luzzani*	NV LU Inox	200150
		Faro*	NV FA S1	200182
	Adria Nouveau modèle/ New type	Mini Bright	NV LU New Inox	200199
ORDENTA		Copie/Copy DCI	NV DCI	200152
PEACH		Peach	NV Adec Inox	200195
PELTON & CRANE		DCI	NV DCI	200152
PLANMECA	Planmeca	DCI	NV DCI	200152
	Ancien modèle/ Old type	Adec	NV Adec Inox	200195
		Luzzani* Mini Bright	NV LU New Inox	200199
	Nouveau modèle/ New type	Luzzani*	NV LU Inox	200150
		Copie/Copy Adec	NV Adex Inox	200195
PRODENT		Luzzani*	NV LU Inox	200150
		Faro*	NV FA S1	200182
PROGRESS		Luzzani*	NV LU V	200173

*Faro et Luzzani ne sont pas des marques déposées par Produits Dentaires Pierre Rolland (groupe Acteon)
*Faro and Luzzani are not trademarks of Produits Dentaires Pierre Rolland (Acteon group)

Fauteuil / Unit	Modèle / Type	Seringue / Syringe	Adaptateur / Adapter	Réf. / Ref.	
PROMA		Adec	NV Adec Inox	200195	
		DCI	NV DCI	200152	
PROMED		Adec	NV Adex Inox	200195	
		Luzzani*	NV LU Inox	200150	
QUALITY DENTA		Copie/Copy DCI	NV DCI	200152	
QDENT		Luzzani*	NV LU Inox	200150	
QUETIN	Ancien modèle/ Old type	Siemens/Sirona	NV Siemens 2000	200177	
		Luzzani* Mini-Light Assistante	NV LU V	200173	
		Luzzani*	NV LU Inox	200150	
		Luzzani* Mini Bright	NV LU New Inox	200199	
		Faro*	NV FA S1	200182	
QUINT		Luzzani*	NV LU Inox	200150	
		Forest	NV Adec Inox	200195	
		DCI	NV DCI	200152	
		Adec	NV Adec Inox	200195	
REDEE		Luzzani*	NV LU Inox	200150	
RIGEL		Luzzani*	NV LU V	200173	
RITTER	Ancien modèle/ Old type	Ritter	NV Ritter Combijet	200175	
		Ritter	NV Ritter Topjet	200176	
	Nouveau modèle/ New type D720 - D740 - D230		Ritter	NV FA S1	200182
			Luzzani*	NV LU Inox	200150
			Adec	NV Adex Inox	200195

*Faro et Luzzani ne sont pas des marques déposées par Produits Dentaires Pierre Rolland (groupe Acteon)
*Faro and Luzzani are not trademarks of Produits Dentaires Pierre Rolland (Acteon group)

Fauteuil / Unit	Modèle / Type	Seringue / Syringe	Adaptateur / Adapter	Réf. / Ref.
SABRO		Luzzani*	NV LU Inox	200150
SDIF		Copie/Copy DCI	NV DCI	200152
		Luzzani*	NV LU Inox	200150
S.D.Z.		Adec	NV Adec Inox	200195
		DCI	NV DCI	200152
SDS Summit Dental		Copie/Copy DCI	NV DCI	200152
SELECT DENTAL		Luzzani*	NV LU Inox	200150
SENTADO		Copie/Copy DCI	NV DCI	200152
SHIN HUNG	Concert	DCI	NV DCI	200152
	Taurus Sante	Siemens/Sirona	NV Sirona B	200154
	Taurus	Morita WS 66	NV Morita 66 Type2	200159
		Faro*	NV FA S1	200182
SINOL		Copie/Copy DCI	NV DCI	200152
		Luzzani*	NV LU Inox	200150
SIE DENTAL		Sie Dental	NV Adec Inox	200195
SIGER (Chine)		Copie/Copy DCI	NV DCI	200152
SIRONA / SIEMENS		Siemens/Sirona	NV Siemens E	200179
		Sprayvit 2000	NV Siemens 2000	200177
	C1/M1/M1+	Sprayvit 4000	NV Siemens 4000 ou/or NV Sirona B	200178 200154
	C2, C2+, C3, C3+, C4	Siemens/Sirona	NV Sirona B	200154
	C4+, C5+, C6, C8, C8+, Profeel+	DCI	NV DCI	200152

*Faro et Luzzani ne sont pas des marques déposées par Produits Dentaires Pierre Rolland (groupe Acteon)
*Faro and Luzzani are not trademarks of Produits Dentaires Pierre Rolland (Acteon group)

Fauteuil / Unit	Modèle / Type	Seringue / Syringe	Adaptateur / Adapter	Réf. / Ref.
SIRONA / SIEMENS	Asia, Polar, Savannah, Mediterranean		NV Sirona B	200154
		Copie/Copy DCI	NV DCI	200152
		Sirona Lumière with Light	NV Sirona L	200196
SIGNATECH		Luzzani*	NV LU Inox	200150
SKY DENTAL (Korea)		Copie/Copy DCI	NV DCI	200152
SLOVADENT		DCI	NV DCI	200152
		Copie/Copy DCI	NV DCI	200152
		Luzzani*	NV LU Inox	200150
STERN WEBER		Luzzani*	NV LU Inox	200150
		Stern	NV Cefla Inox	200197
	Nouveau modèle/ New type	Mini Bright	NV LU New Inox	200199
		Nlle/New Cefla	NV Cas Inox	200198
SUN DARB		Copie/Copy DCI	NV DCI	200152
SUPERDENTA		Luzzani*	NV LU Inox	200150
SWIDENT		Luzzani*	NV LU Inox	200150
		Mini Bright	NV Lu New Inox	200199
TECKNIKA		Luzzani*	NV LU Inox	200150
TECNOMED		Luzzani*	NV LU Inox	200150
		Mini Bright	NV Lu New Inox	200199
TEKMIL		Luzzani*	NV LU V	200173
		Luzzani*	NV LU Inox	200150
		Faro*	NV FA S1	200182

*Faro et Luzzani ne sont pas des marques déposées par Produits Dentaires Pierre Rolland (groupe Acteon)
*Faro and Luzzani are not trademarks of Produits Dentaires Pierre Rolland (Acteon group)

Fauteuil / Unit	Modèle / Type	Seringue / Syringe	Adaptateur / Adapter	Réf. / Ref.
T.G.A		Faro*	NV FA C ou/or NV FA C2	200167 200168
		Luzzani*	NV LU Inox	200150
THOMAS		Faro*	NV FA C ou/or NV FA C2	200167 200168
		Luzzani*	NV LU Inox	200150
		Copie/Copy DCI	NV DCI	200152
THOMAS DENTAL GERATE		Luzzani*	NV LU Inox	200150
TOP DENTAL		Luzzani*	NV LU Inox	200150
TRIDAC		Tridac	NV Tridac II	200190
ULTRADENT		Faro*	NV FA C ou/or NV FA C2	200167 200168
		Siemens/Sirona	NV Siemens 4000	200178
		Siemens/Sirona	NV Sirona B	200154
VICTOR DENTAL		Copie/Copy DCI	NV DCI	200152
VITALI		Luzzani*	NV LU Inox	200150
		Luzzani* (certains anciens modèles / some old types)	NV LU Inox + Piece / Part 447	200150 203969
	CLIP 6	Luzzani*	NV LU V	200173
VISIO		Luzzani*	NV LU V	200173
WESTECH		Adec	NV Adec Inox	200195
		Luzzani*	NV LU Inox	200150
WILLIAM GREEN		Luzzani*	NV LU Inox	200150

*Faro et Luzzani ne sont pas des marques déposées par Produits Dentaires Pierre Rolland (groupe Acteon)
*Faro and Luzzani are not trademarks of Produits Dentaires Pierre Rolland (Acteon group)

Fauteuil / Unit	Modèle / Type	Seringue / Syringe	Adaptateur / Adapter	Réf. / Ref.
WOSON		Copie/Copy DCI	NV DCI	200152
YOSHIDA	Dernier modèle/ Last type Exceed Plus	Yoshida V	NV Yoshida V	200180
		Copie/Copy DCI	NV DCI	200152
		Yoshida	NV Yoshida 3	200193
XO		Luzzani*	NV LU Inox	200150
		Copie/Copy DCI	NV DCI	200152
		Copie/Copy Adec	NV Adec Inox	200195

*Faro et Luzzani ne sont pas des marques déposées par Produits Dentaires Pierre Rolland (groupe Acteon)
*Faro and Luzzani are not trademarks of Produits Dentaires Pierre Rolland (Acteon group)

4

INCIDENTS COURANTS ET SOLUTIONS

TROUBLESHOOTING

INCIDENT	DEPISTAGE / DETECTION	SOLUTION
<p>Difficulté pour monter l'adaptateur</p> <p>Difficulty to set up the adapter</p>	<p>Vérifier que la référence de l'adaptateur corresponde bien à votre type de seringue. Vérifier le montage correct de l'adaptateur sur la seringue. Check you have the right adapter to fit your type of syringe. Check the correct set up of the adapter on the syringe.</p>	<p>Contacter le vendeur de la Société PIERRE ROLLAND Lire attentivement les instructions de montage.</p> <p>Contact your PIERRE ROLLAND salesperson. Read carefully the assembly instructions.</p>
<p>Difficulté pour placer l'adaptateur sur la seringue</p> <p>Difficulty to fit up the adapter on the syringe</p>	<p>Vérifier que les joints de l'adaptateur et de la seringue ont été lubrifiés. Vérifier l'état des clips (anneaux en métal) de la seringue. Check the O-rings of the adapter and the syringe have been lubricated. Check the good shape of the clips (metal rings) of the syringe.</p>	<p>Lubrifier les joints avant de mettre en place l'adaptateur. Faire changer cette pièce par la maintenance de votre fauteuil. Lubricate the O-rings before setting up the adapter. Ask the person in charge of the maintenance of your unit to change this part.</p>
<p>Perte de puissance de ou des sorties eau-air après montage de l'adaptateur</p> <p>Loss of power of the air-water jet after setting up the adapter</p>	<p>Vérifier le réglage de la pression de l'eau et de l'air du fauteuil (la différence entre la pression de l'eau et celle de l'air ne doit pas excéder 1 bar). Check the air and water pressure of the unit (the difference between the water and air pressure should not exceed 1 bar).</p>	<p>Régler la pression de l'air du fauteuil à 3,5 bars minimum (environ 50 PSI). Set the air pressure of the unit at 3.5 bars minimum (about 50 PSI).</p>
<p>Eau passant par la sortie d'air de la seringue</p>	<p>Vérifier le réglage de la pression de l'eau et de l'air du fauteuil (la différence entre la pression de l'eau et celle de l'air ne doit pas excéder 1 bar).</p>	<p>La pression de l'air du fauteuil doit être réglée à 3,5 bars minimum (environ 50 PSI).</p>

INCIDENT	DEPISTAGE / DETECTION	SOLUTION
<p>Water through the air jet of the syringe</p>	<p>Check the good setting of the water and air pressure of the unit (the difference between the water and air pressure should not exceed 1 bar).</p>	<p>The air pressure of the unit must be set at 3.5 bars minimum (about 50 PSI).</p>
<p>Fuite d'eau entre l'adaptateur et l'embout jetable</p> <p>Water leak between the adapter and the disposable tip</p>	<p>Vérifier que l'embout jetable est mis en place correctement sur l'adaptateur. Check the disposable tip is set correctly on the adapter.</p>	<p>Mettre en place correctement l'embout jetable sur l'adaptateur. Set correctly the tip on the adapter.</p>
<p>Mauvais spray pas assez puissant</p> <p>Bad spray, not enough strong</p>	<p>Vérifier le réglage de la pression de l'eau et de l'air du fauteuil (la différence entre la pression de l'eau et de l'air ne doit pas excéder 1 bar). Check the good setting of the water and air pressure of the unit (the difference between the water and air pressure should not exceed 1 bar).</p>	<p>La pression de l'air du fauteuil doit être réglée à 3,5 bars minimum (environ 50 PSI). The air pressure of the unit must be set at 3.5 bars minimum (about 50 PSI).</p>
<p>Absence de sortie d'eau ou d'air (ou des deux) de l'embout jetable</p> <p>Absence of water or air (or both) discharge from the tip</p>	<p>Vérifier la mise en place de l'embout sur l'adaptateur. Check the setting up of the tip on the adapter</p>	<p>Déboucher les 2 tubes de l'adaptateur avec un instrument (tire-nerf). Clear the 2 tubes of the adapter with an instrument (barbed broach).</p>
<p>Problème d'eau dans l'air après le montage de l'adaptateur</p> <p>Problem of water in the air after the set up of the adapter</p>	<p>Vérifier l'état des joints de la seringue. Check the good shape of the O-rings of your syringe.</p>	<p>Changer les joints de la seringue en mauvais état. Change the O-rings of the syringe in bad shape.</p>

INCIDENT	DEPISTAGE / DETECTION	SOLUTION
<p>Problème d'eau dans l'air après montage de l'adaptateur (NV) ADEC Inox ou de tout autre adaptateur se vissant sur la seringue</p> <p>Problem of water in the air tube after setting up of the adapter ADEC Inox or any other adapter screwed on the syringe</p>	<p>Vérifier le positionnement et l'état du petit joint au bout de l'adaptateur.</p> <p>Check the positioning and the good shape of the small O-ring at the end of the adapter.</p>	<p>Dévisser l'adaptateur, remettre le petit joint en place, le changer s'il est en mauvais état et revisser l'adaptateur.</p> <p>Unscrew the adapter, set the small O-ring at the right place, change it if it is in bad shape and screw again the adapter.</p>
<p>Problème d'eau dans l'air après montage de l'adaptateur pour seringue DCI</p> <p>Problem of water in the air tube after setting up of the adapter for DCI syringe</p>	<p>Vérifier l'état du joint à l'intérieur de la seringue.</p> <p>Check the good shape of the O-ring inside the syringe.</p>	<p>Changer le joint à l'intérieur de la seringue.</p> <p>Change the O-ring inside the syringe.</p>
<p>Problème d'eau dans l'air sur la seringue KAVO DB, Kavo GB, Kavo HB</p> <p>Problem of water in the air on the syringe KAVO DB, Kavo GB, Kavo HB</p>	<p>Vérifier l'état des joints de la seringue.</p> <p>Check the good shape of the O-rings.</p>	<p>Changer les joints de la seringue en mauvais état.</p> <p>Change the O-rings of the syringe in bad shape.</p>
<p>Problème de mise en place de l'adaptateur sur la dernière seringue Sirona (noire avec des boutons bleus)</p> <p>Sirona B onto the latest Sirona syringe (black with blue buttons)</p>	<p>Vérifier l'état de la bague en métal de la seringue (le clip).</p> <p>Verify the good shape of the metal ring on the syringe (the clip).</p>	<p>Changer ce clip si il est en mauvais état.</p> <p>Change the metal ring of the syringe if the shape is not good.</p>

5

INDEX DES ADAPTATEURS

ADAPTERS INDEX

A	
NV Adec Inox - ref 200 195	10

B	
NV Belmont New - ref 200 158.....	13

C	
NV Cas Inox - ref 200 198	12-14-50
NV Castellini Logo New - ref 200 184	15-16
NV Castellini V - ref 200 163	17
NV Cefla Inox - ref 200 197.....	11-49

D	
NV DCI - ref 200 152	18
NV Dentalez - ref 200 164.....	19

E	
NV Engle - ref 200 194.....	20

F	
NV FA C - ref 200 167.....	21
NV FA C2 - ref 200 168.....	22
NV FA E - ref 200 165.....	23
NV FA E2 - ref 200 166.....	24
NV FA S1 - ref 200 182.....	25
NV Flex - ref 200 169	26

K	
NV Kavo C - ref 200 171	27
NV Kavo DB - ref 200 157.....	28
NV Kavo E - ref 200 172.....	29
NV Kavo GB - ref 200 156.....	30
NV Kavo HB - ref 200 153.....	31
NV Kavo IB - ref 200 192	32
NV Kavo J - ref 200 181.....	33
NV Kavo K - ref 200 160.....	34

L	
NV LU Inox - ref 200 150.....	35
NV LU V - ref 200 173	36
NV LU New Inox - ref 200 199	37

M	
NV Morita 66 Type 2 - ref 200 159	38
NV Morita S12 - ref 200 183.....	39
NV Morita Inox WS10 - ref 200 201	40
NV Morita Inox WS97 - ref 200 200	41

P	
Piece 222 / Part 222 - ref 203 976	35
Piece 447 / Part 447 - ref 203 969	35
Piece 344C / Part 344C - ref 203 960.....	35

R	
NV Ritter Combijet - ref 200 175.....	42
NV Ritter Topjet - ref 200 176.....	43

S	
NV Siemens 2000 - ref 200 177	44
NV Siemens 4000 - ref 200 178	45
NV Siemens E - ref 200 179.....	46
NV Sirona B - ref 200 154.....	47
NV Sirona L - ref 200 196	48

T	
NV Tridac II - ref 200 190	51

Y	
NV Yoshida 3 - ref 200 193	52
NV Yoshida V - ref 200 180	53

Ce document est la propriété du Laboratoire PRODUITS DENTAIRE PIERRE ROLLAND.
Il n'est pas contractuel et est destiné aux délégués Pierre Rolland et réseaux de distribution.
Les informations contenues dans ce catalogue sont valables à la date d'impression.
This document is the PRODUITS DENTAIRE PIERRE ROLLAND Laboratory property.
It is not contractual and is intended to Pierre Rolland representatives and distribution system.
The data contained in this catalogue are valid at the printing date.

Tous droits d'auteur réservés pour tous pays. Toute reproduction intégrale ou partielle par quelque procédé que ce soit, faite sans le consentement écrit et préalable du Laboratoire PRODUITS DENTAIRE PIERRE ROLLAND, est illicite et constitue une contrefaçon donnant lieu à des sanctions pénales.
All author rights reserved for all countries. Any entire or part copy made by any way without the writing and previous agreement of the PRODUITS DENTAIRE PIERRE ROLLAND Laboratory is unlawful and constitutes a fraudulently copying given rise to penalties.

Dispositifs médicaux de classe I – CE. Réservés à l'usage professionnel.
Lire attentivement les instructions figurant dans la notice.
Fabricant : Produits Dentaires Pierre Rolland - France.
Toutes les informations indispensables pour un bon usage de ces dispositifs figurent dans le résumé des caractéristiques du produit disponible sur le site du laboratoire. Non remboursés par les organismes d'assurance maladie. Date de création : janvier 2017.
Class I medical device - CE. For professional use only.
Read the instructions in the notice carefully.
Manufacturer: Produits Dentaires Pierre Rolland - France.
All information that is essential to ensure correct use of these devices is included in the summary of the product characteristics available on the laboratory's website. Not reimbursed by health insurance organisations. Created in: January 2017

Réf. 299097 (01/2017)